

123RFID

Mobile Application



ZEBRA

User Guide

2025/03/28

ZEBRA and the stylized Zebra head are trademarks of Zebra Technologies Corporation, registered in many jurisdictions worldwide. All other trademarks are the property of their respective owners. ©2025 Zebra Technologies Corporation and/or its affiliates. All rights reserved.

Information in this document is subject to change without notice. The software described in this document is furnished under a license agreement or nondisclosure agreement. The software may be used or copied only in accordance with the terms of those agreements.

For further information regarding legal and proprietary statements, please go to:

SOFTWARE: zebra.com/informationpolicy.

COPYRIGHTS: zebra.com/copyright.

PATENTS: ip.zebra.com.

WARRANTY: zebra.com/warranty.

END USER LICENSE AGREEMENT: zebra.com/eula.

Terms of Use

Proprietary Statement

This manual contains proprietary information of Zebra Technologies Corporation and its subsidiaries ("Zebra Technologies"). It is intended solely for the information and use of parties operating and maintaining the equipment described herein. Such proprietary information may not be used, reproduced, or disclosed to any other parties for any other purpose without the express, written permission of Zebra Technologies.

Product Improvements

Continuous improvement of products is a policy of Zebra Technologies. All specifications and designs are subject to change without notice.

Liability Disclaimer

Zebra Technologies takes steps to ensure that its published Engineering specifications and manuals are correct; however, errors do occur. Zebra Technologies reserves the right to correct any such errors and disclaims liability resulting therefrom.

Limitation of Liability

In no event shall Zebra Technologies or anyone else involved in the creation, production, or delivery of the accompanying product (including hardware and software) be liable for any damages whatsoever (including, without limitation, consequential damages including loss of business profits, business interruption, or loss of business information) arising out of the use of, the results of use of, or inability to use such product, even if Zebra Technologies has been advised of the possibility of such damages. Some jurisdictions do not allow the exclusion or limitation of incidental or consequential damages, so the above limitation or exclusion may not apply to you.

Contents

About this Document.....	5
Related Documents.....	5
Notational Conventions.....	5
Service Information.....	6
123RFID Mobile Application.....	7
Requirements.....	7
Installing the 123RFID Mobile Application for Android.....	7
123RFID Mobile Application for Android.....	8
Using the 123RFID Mobile Application for Android.....	8
Navigating 123RFID Mobile.....	8
Accessing Battery Statistics.....	10
Renaming a Reader.....	13
Readers List (Available vs. Connected).....	16
Connect a Reader.....	19
Connect to Reader Directly Using USB/Common IO.....	20
Connect to Reader Using Bluetooth.....	20
RFID Operations.....	30
Rapid Read.....	30
Inventory.....	32
Locate Tag.....	42
Basic Pre Filters.....	44
Tag Write.....	45
Settings.....	49
General Settings.....	50

RFID Settings.....	70
Application Settings.....	90
Enabling SGTIN-96.....	91
U9 Tags.....	93
Scan Settings.....	97
Certificates Management Settings.....	98
Endpoint Configuration Settings.....	100
Getting Help.....	103

About this Document

This guide provides detailed information about the 123RFID Mobile Application for Android.

Related Documents

The following documents provide more information about RFID products that support 123RFID Mobile Application for Android:

- MC3300R RFID Mobile Computer Integrator Guide Supplement, p/n MN-003180-xx
- RFD2000 RFID Sled User Guide, p/n MN-003128-xx
- RFD8500 User Guide, p/n MN002065Axx
- RFD40 Product Reference Guide, p/n MN-004189-xx
- RFD4031 Product Reference Guide, p/n MN-004373-xx

Notational Conventions

The following notational conventions make the content of this document easy to navigate.

- **Bold** text is used to highlight the following:
 - Dialog box, window, and screen names
 - Dropdown list and list box names
 - Checkbox and radio button names
 - Icons on a screen
 - Key names on a keypad
 - Button names on a screen
- Bullets (•) indicate:
 - Action items
 - List of alternatives
 - Lists of required steps that are not necessarily sequential
- Sequential lists (for example, those that describe step-by-step procedures) appear as numbered lists.

Service Information

If you have a problem with your equipment, contact Zebra Global Customer Support for your region. Contact information is available at: zebra.com/support.

When contacting support, please have the following information available:

- Serial number of the unit
- Model number or product name
- Software/firmware type and version number

Zebra responds to calls by email, telephone, or fax within the time limits set forth in support agreements.

If your problem cannot be solved by Zebra Customer Support, you may need to return your equipment for servicing and will be given specific directions. Zebra is not responsible for any damages incurred during shipment if the approved shipping container is not used. Shipping the units improperly can possibly void the warranty.

If you purchased your Zebra business product from a Zebra business partner, contact that business partner for support.

123RFID Mobile Application

This chapter describes the enhanced version of the 123RFID Mobile Application for Android which demonstrates the device's capability and tag operation functionality.

This application is also available as part of Google Play store at: play.google.com/store/apps/details?id=com.zebra.rfidreaderAPI.demo&hl=en.

Requirements

Requirements for the 123RFID Mobile Application for Android are as follows:

- The recommended Android version on the mobile computer is Nougat version 7 and above.
- Zebra Enterprise RFID mobile computer and Android devices, such as the MC3300xR, compatible with RFD8500 or Zebra approved mobile computer compatible with the RFD40 Standard RFID and RFD4031 Premium/Premium+ sleds.
- Zebra RFID Manager APK. **NOTE:** The Zebra RFID Manager APK is only required when using RFD2000 products. Refer to the appropriate guide for more information.
- 123RFID Mobile Application APK.

Installing the 123RFID Mobile Application for Android

Install the 123RFID Mobile Application on the mobile computer from zebra.com/support or from the Google Play Store. The procedure to install the software on an Android device is dependent upon the Android version.

To install the software:

1. Connect the Android device to your computer. It is connected as MTP Device and shown as a drive on the computer.

For information on transferring files using Media Transfer Protocol, refer to the Mobile Computer Integrator Guide at: zebra.com/support.

2. Navigate to **Device Settings > Security** and check **Unknown Sources** to allow installation of applications from unknown sources.
3. Copy the 123RFID_Mobile_1.0.x.x.apk file to the mobile device.
4. Use the File Manager to locate the 123RFID_Mobile_1.0.x.x.apk file in the folder to which it is copied in Step 3 and select it.

5. In the pop-up window, select the Android App installer to begin installation.

123RFID Mobile Application for Android

This application runs on Android mobile devices and demonstrates capability and tag operation functionality.

The application allows for navigating to all screens at any time, however, some actions are not permitted while the device is charging. These actions include any operation that involves Tag reading or writing (for example: Rapid Read, Inventory, Locate Tag, etc.).

Navigate to all screens when the inventory/locate operation is in progress. When the operation is in progress, the device displays Operation in Progress if additional operations are initiated.

Using the 123RFID Mobile Application for Android



NOTE: By default, the fastest read profile is selected to configure the reader for the maximum power allowed based on the read profile. However, the dBm can be limited due to the regulatory requirements of the specified region in which the sled is being used.

To use the application for RFID operations:

1. Launch the 123RFID Mobile Application for Android on the mobile device.
2. Select **Regulatory** to set the region where the device is operating.
3. From the **Readers** list, tap the available device listed under **Available Readers** to connect and view the Rapid Read screen.
4. Tap **Settings > RFID > Advanced Reader Options > Antenna**.

Navigating 123RFID Mobile

Use the **Home** screen, menu, or bottom navigation bar to navigate. You can switch between the **Inventory**, **Locate**, or **Rapid Read** screens by tapping the appropriate icon.

To exit the application, tap **Back** on the confirmation screen and click **OK**.

Home Screen

To access the 123RFID Mobile Application for Android, touch the **Zebra RFID Reader** icon on the mobile device to display the Home screen.

Menu

To access the menu, tap . The menu options include:

- Readers
- Battery Statistics
- Firmware Update
- Help

- Settings

To disconnect the connected reader, tap the **Disconnect** reader button.



NOTE: The battery life (percentage charged) displays on the menu. Tap the battery icon to access battery statistics.

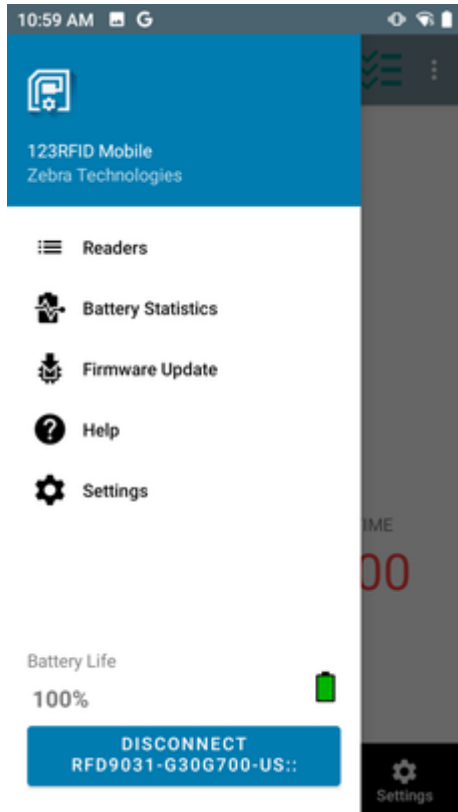

Navigation Bar

The Navigation Bar consists of the following tabs:

- **Readers** - displays a list of connected readers and available readers. Upon initial launch of the application, this is the tab that displays, unless the connection to the reader is over USB/CommonIO.
- **RFID** - select from RFID Settings, Locate Tag, Pre Filters, and Tag Write. This is the tab that displays most of the time when launching the application. If the reader has been previously connected to the app or the reader is connected over USB/Common IO.
- **Scan** - scan barcodes, view the list of scanned barcodes, or clear the scanned list.



NOTE: Available only on RFID sleds with a built-in imager.

- **Settings** - configure General, RFID, Application, and Scan settings.



Accessing Battery Statistics

There are multiple ways to access Battery Statistics.

- Tap **Settings** > **General Settings** and tap **Battery Settings** or tap  on the navigation bar and click **Battery Statistics**.

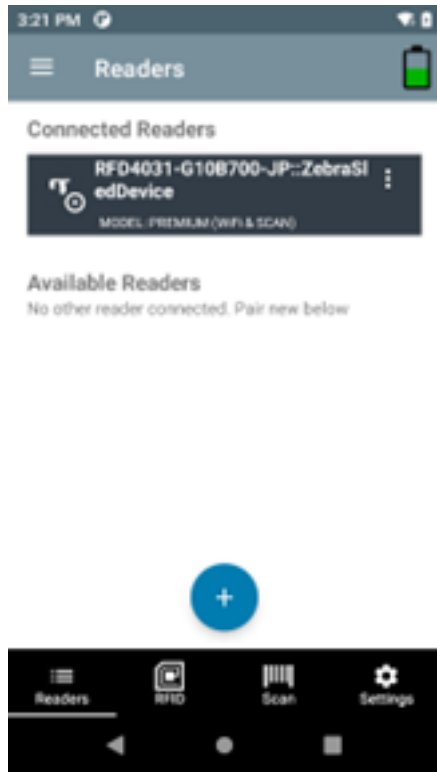

- Tap the menu icon from the top left and tap **Battery Statistics**.

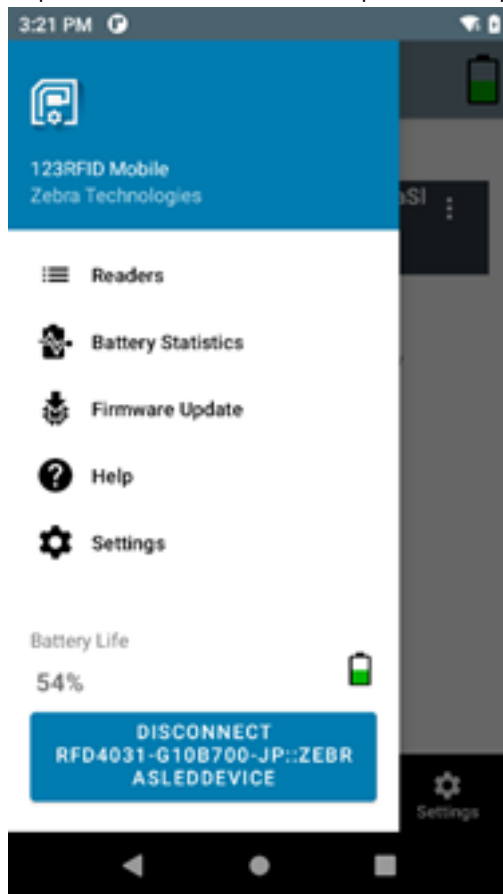

- Tap the **Battery** icon from the top right corner.

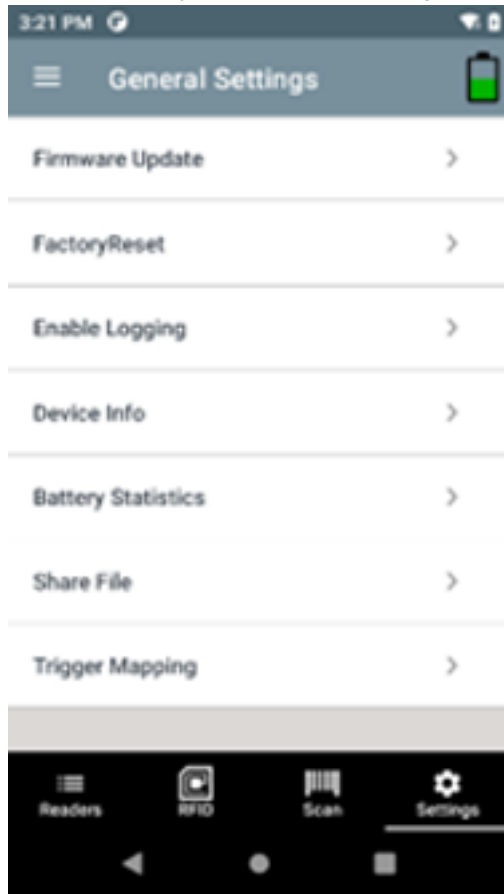

Observe the **Battery Statistics** screen for details on the state of health, charge capacity, charge status, and temperature.

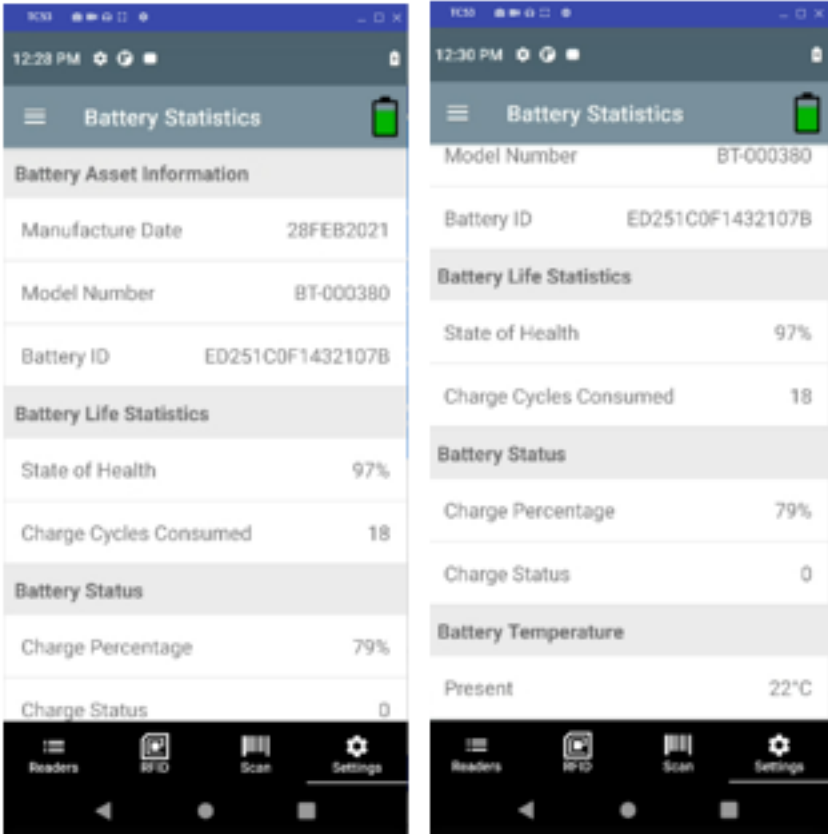

Renaming a Reader

To rename a reader:

1. Tap  and select Rename Reader.

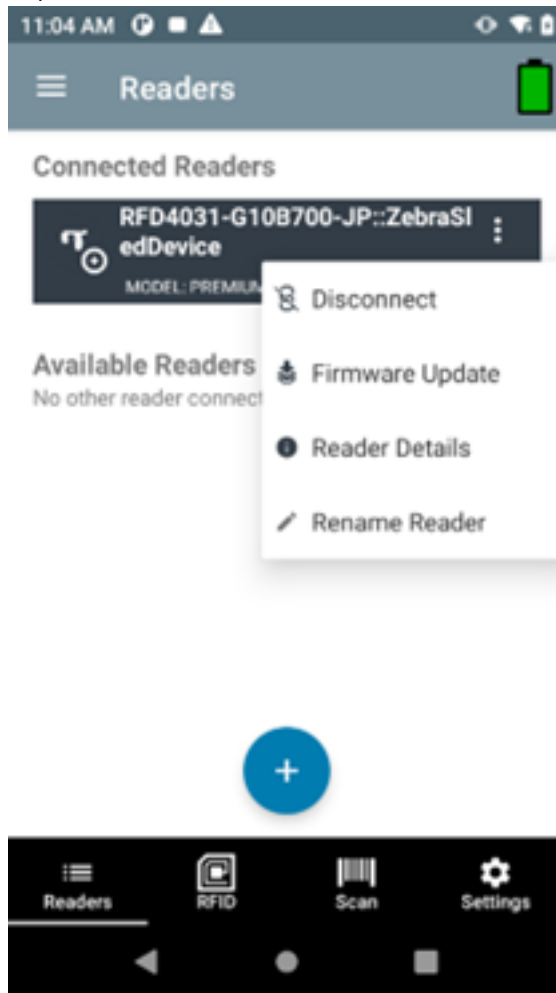

2. Update the new name and click OK.

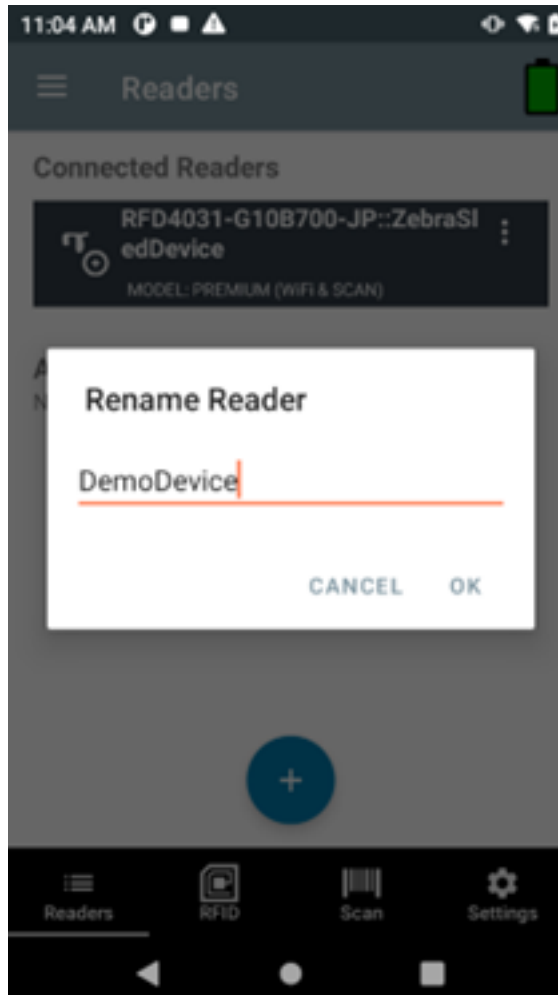

Observe the rename success message.

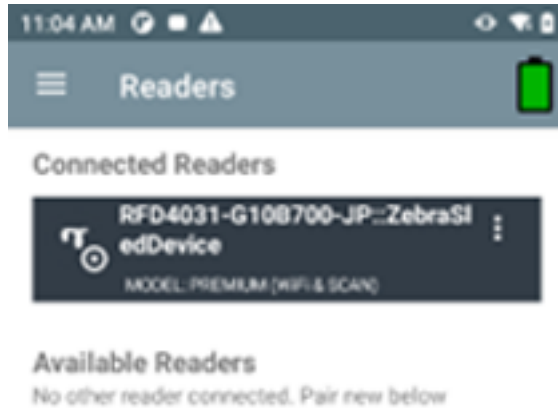

NOTE: Repair or reattach the device to the corresponding Bluetooth or CIO connections to reflect the changes.

Readers List (Available vs. Connected)

The **Readers** list displays connected readers and available readers. After accessing 123RFID Mobile application for the first time, when no readers are available or connected, the following screen displays.

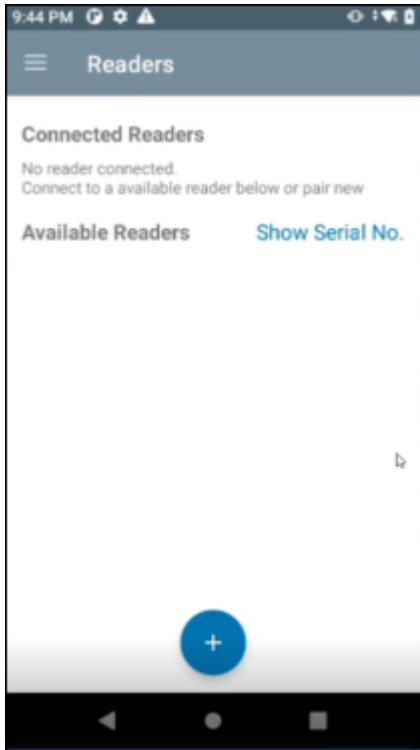

- **Available Readers** - Lists the already paired devices that the user can choose to connect from.

- Available options include:
 - Connect
 - Unpair



NOTE: Tap the ellipses on an **Available Reader** to connect, unpair or view reader details.

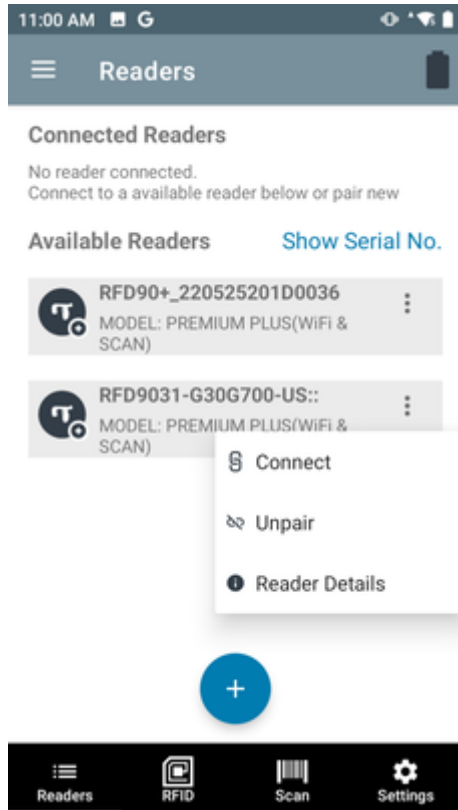

- **Connected Readers** - Lists the readers that are already connected and ready for use.

- Available options include:
 - Disconnect
 - Perform a firmware update
 - View reader details for a connected reader.

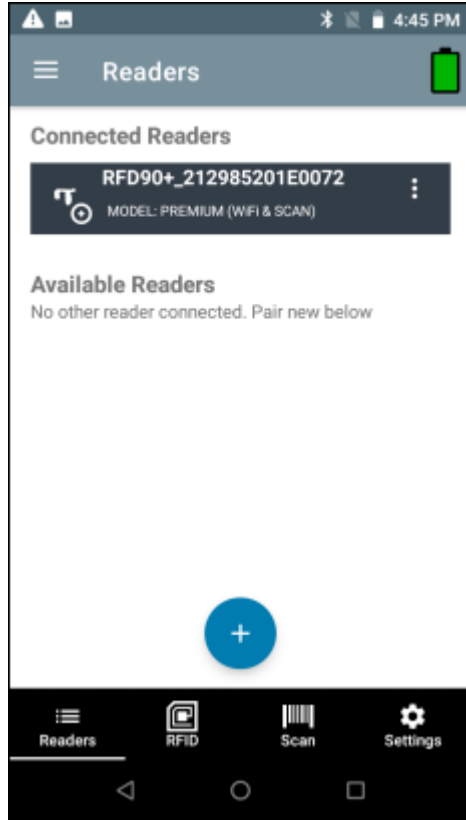

IMPORTANT: Tap the + button to connect to a reader. You can only connect to one device at a time.



NOTE: The model name and description display under the reader's name. To view the serial number, tap **Show Serial No.** Tap a second time to hide the serial number.

Connect a Reader



NOTE: A reader can be connected directly to the 8 pin common IO port (RFD40/RFD90 sleds only) or by using one of the three Bluetooth options.

To connect a reader:

1. From the bottom navigation bar, tap the **Readers** icon.
2. Tap a reader name from the **Available Readers** list to establish a session with the selected reader.
3. Tap again to terminate the session.
4. To obtain additional information about the device, tap **Reader Details** within Connected Readers or Available Readers.

See Also

[Connect to Reader Directly Using USB](#)

[Connect to Reader Using Bluetooth](#)

Connect to Reader Directly Using USB/Common IO

There is no need to go through any manual steps or pairing. When connecting the RFD40 using USB, it connects directly.



NOTE: Use a USB eConnex pin if using the RFD40, or USB Serial connection if using the RFD2000.

1. Connect the RFD40 to USB.
2. Launch 123RFID Mobile App.

The RFID Rapid Read screen displays.

The RFD40 is directly connected.

Connect to Reader Using Bluetooth

Using Bluetooth, you can pair and connect to a reader in the following ways:

- Tap and Pair
- Scan and Pair
- Pair using Barcode

Pair Reader Using NFC Tag (Tap and Pair)



NOTE: Available only on RFD40 Premium and Premium +.

To pair a reader using the NFC tag:

1. From the bottom Navigation Bar, tap **Readers**.
2. Tap + icon.

- To connect via NFC, align the NFC area behind the handle of the sled with the NFC area on the back of the mobile computer to pair.

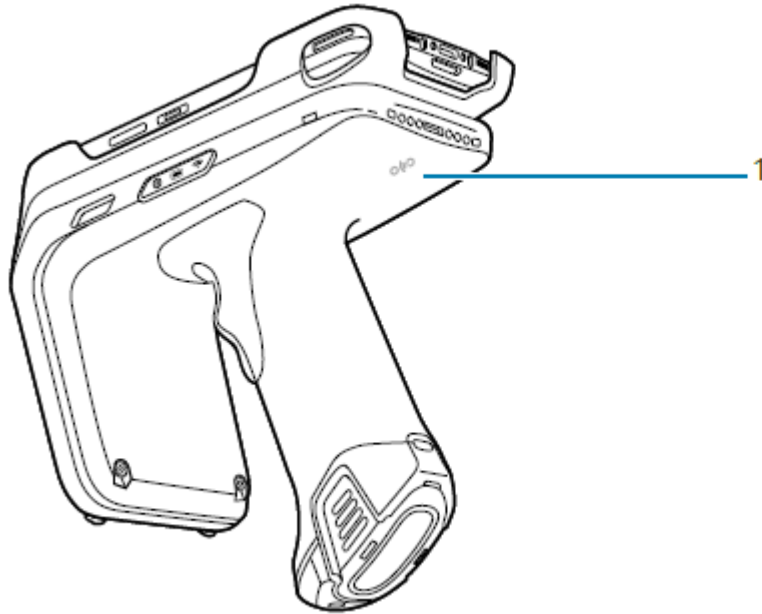

- On the **Pair with** screen:
 - (Optional) Check **Allow access to your contacts and call history**.
 - Tap **PAIR**.

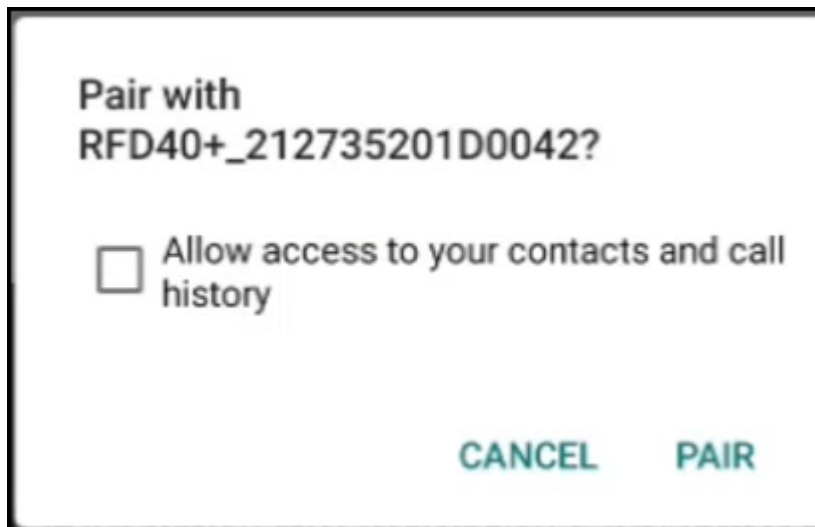

The reader is paired with the mobile computer and the reader displays in the **Available Readers** list.. Once the sled has paired with a mobile computer, the sled recognizes the device going forward and automatically connects using the 123RFID Mobile Reader Discovery feature. From the Readers list, select the checkbox for the paired reader and tap **UNPAIR** to unpair the reader from the mobile computer.

Scan and Pair - RFD40



NOTE: Available only for Zebra Enterprise Mobile Computing devices and not third party Android devices.

The RFD40 Premium + can connect to a host device over Bluetooth via Scan & Pair.

1. From the bottom Navigation Bar, tap **Readers**.
2. Tap + icon > Scan.
3. To connect via scan, scan the code on the sled using the mobile computer to obtain the Bluetooth MAC address to pair the device to the sled or you can scan the serial number of the device.

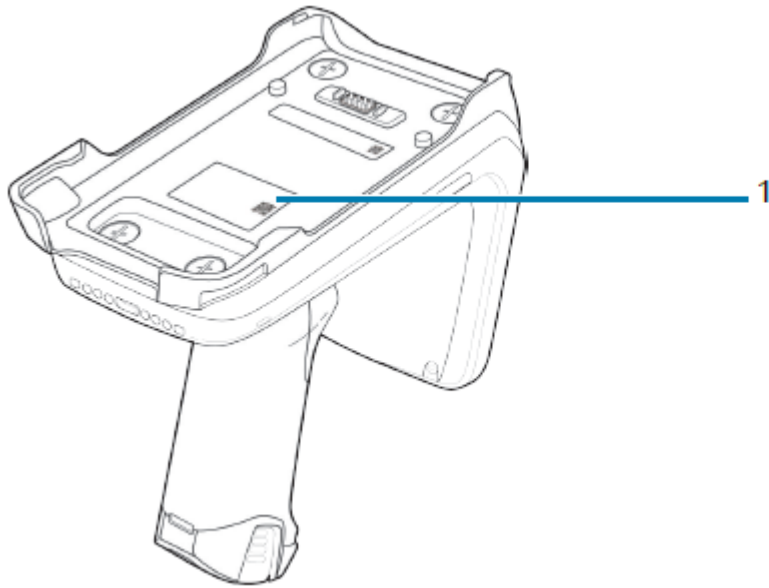

4. Tap **PAIR**.

5. On the **Pair with** screen:
 - a) (Optional) Check **Allow access to your contacts and call history**.
 - b) Tap **PAIR**.

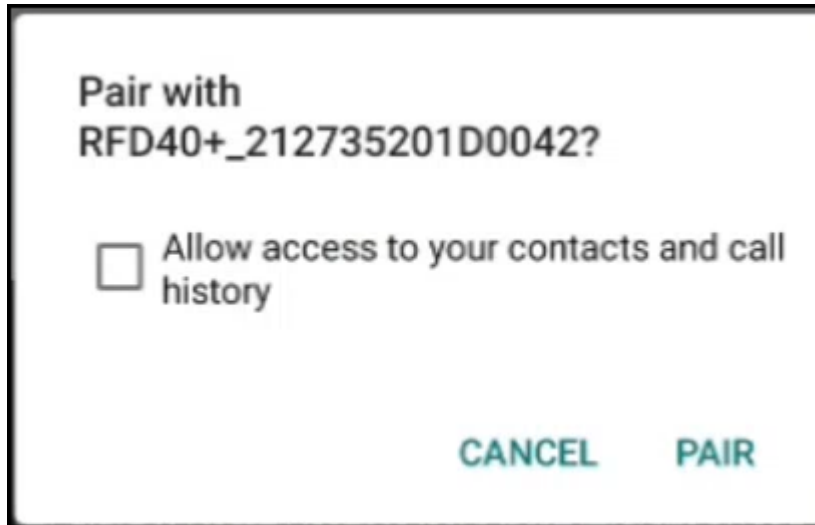

The reader is paired with the mobile computer and the reader displays in the **Available Readers** list..

Once the sled has paired with a mobile computer, the sled recognizes the device going forward and automatically connects using the 123RFID Mobile Reader Discovery feature.

From the Readers list, select the checkbox for the paired reader and tap **UNPAIR** to unpair the reader from the mobile computer.

Scan and Pair - RFD8500

Pairing with the RFD8500 is completed from the Android platform via Bluetooth Settings on the mobile device.

Prior to pairing the RFD8500 with another device ensure the RFD8500 is charged.



IMPORTANT: For successful pairing of the RFD8500 to an Android device, the yellow trigger on the RFD8500 must be pressed when the RFD8500 displays in the list of available discoverable devices, and the RFD8500 Bluetooth LED starts flashing fast.

To pair with an Android device:

1. Power on the device.
2. Touch **Settings > Connected devices**.
3. Turn Bluetooth on.
4. Touch **Search for Devices** to display the available discoverable devices.
5. Turn the RFD8500 on and ensure Bluetooth is enabled. If not, press the Bluetooth button on the RFD8500 for one second to make it discoverable. When discoverable, the Bluetooth LED flashes blue.



NOTE: The RFD8500 is discoverable over Bluetooth for 40 seconds after start up. After that time Bluetooth suspends and is no longer discoverable. To restart discovery, press the Bluetooth button for one second.

6. When the RFD8500 displays in the list of available discoverable devices, tap the RFD8500 device in the list and press the RFD8500 trigger to pair when the Bluetooth LED starts flashing fast. A beep sounds when pairing completes successfully.



NOTE: Ensure you choose the correct RFD8500 serial number from the list of discoverable devices.

7. Exit the Device Settings screen and run the application.
8. From the application, select **Readers** and confirm that the RFD8500 serial number you paired with is displayed. Select it in the list of Available Readers. This connects the RFD8500 to the mobile device.

Pair Reader By Scanning a Barcode



NOTE: Available only on RFD40 Premium +.

To pair a reader by scanning a barcode:

1. From the bottom Navigation Bar, tap **Readers**.
2. Tap + icon > Barcode.
3. The very first time after you install the application, you will need to provide the Bluetooth address of the mobile computer. Navigate to **Settings > About Phone > Status > Bluetooth Address** or click the **click here** link on the **Please Enter Your Bluetooth Address** screen.

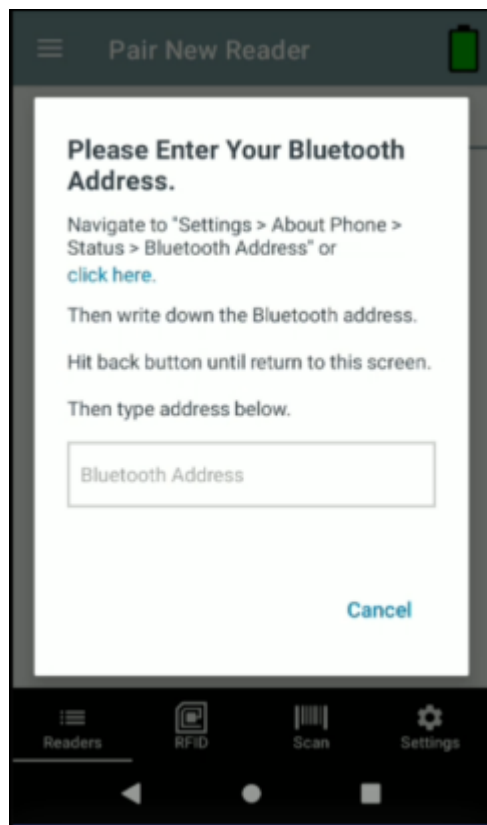

The **Settings** screen displays where you can locate the **Bluetooth address**.

4. Tap **Bluetooth address** and tap **Copy**.
5. Paste the Bluetooth address in the **Bluetooth Address** field on the **Please Enter Your Bluetooth Address** screen.
6. Tap **Continue**.

Once you do that, it sets the Bluetooth address barcode for you.

7. Scan the barcode using the sled.

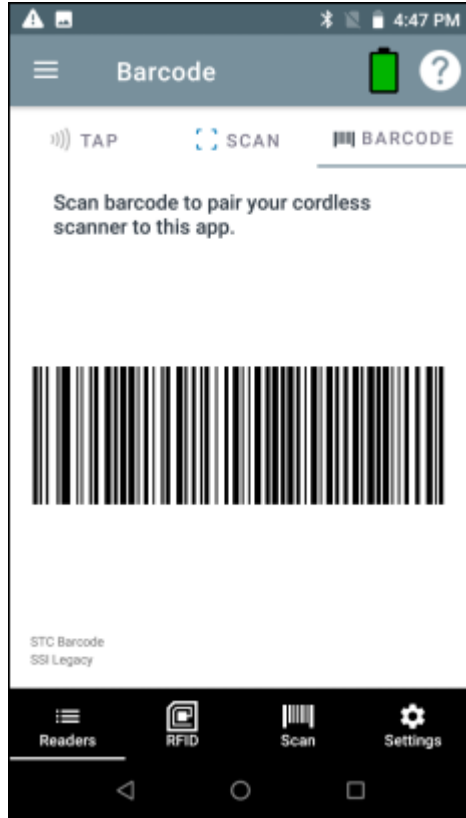

8. Tap **PAIR**.

9. On the **Pair with** screen:
 - a) (Optional) Check **Allow access to your contacts and call history**.
 - b) Tap **PAIR**.

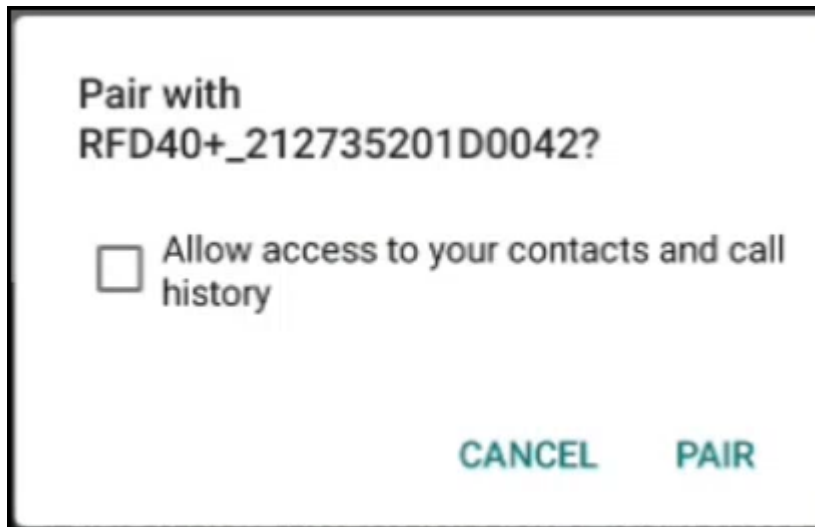

The reader is paired with the mobile computer and the reader displays in the **Available Readers** list..

Once the sled has paired with a mobile computer, the sled recognizes the device going forward and automatically connects using the 123RFID Mobile Reader Discovery feature.

From the Readers list, select the checkbox for the paired reader and tap **UNPAIR** to unpair the reader from the mobile computer.

Pairing with the Camera

Use the camera on the mobile computer to pair the device to the sled.

- 1. Pair the sled using the camera on the mobile computer by tapping the **Camera** tab.

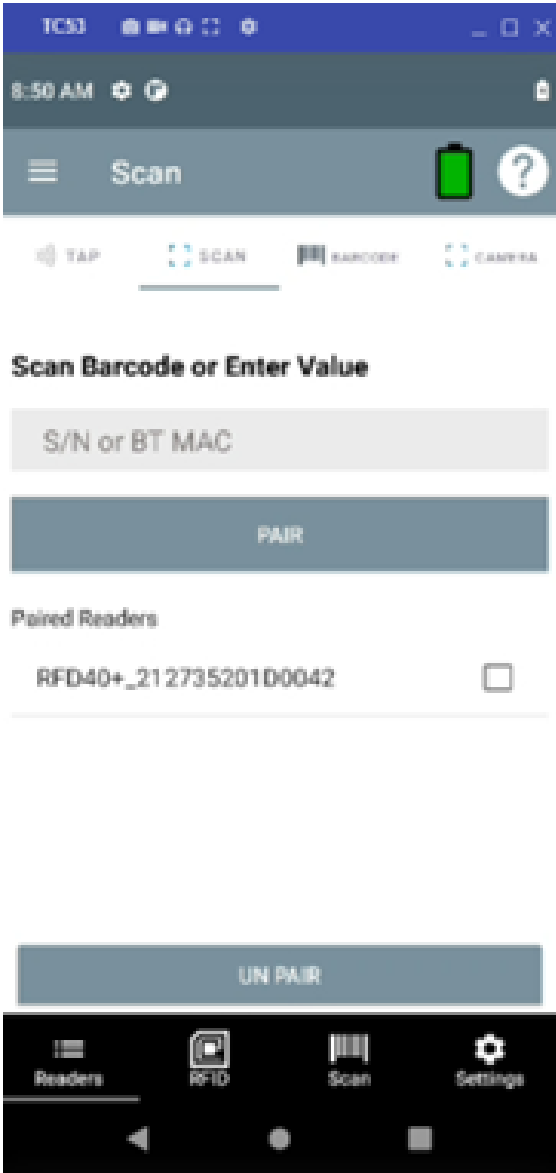

2. On the Camera tab, tap **Scan** to access the camera on the mobile computer.



3. Once the camera is activated, tap the screen on the mobile computer to capture the barcode on the sled.



Pair Reader Manually

If you do not use the Tap and Pair, Scan and Pair, or Scan a Barcode method to pair the reader, you can pair it manually.

1. Enable Bluetooth.
2. Discover Bluetooth devices.
3. Connect to a Bluetooth device.

See Also

[Enabling Bluetooth](#)

[Discovering Bluetooth Devices](#)

[Connecting to a Bluetooth Device](#)

Enabling Bluetooth

1. Swipe down from the Status bar to open the Notification panel.
2. Touch  to turn Bluetooth on.

Discovering Bluetooth Device(s)

The device can receive information from discovered devices without pairing. However, once paired, the device and a paired device exchange information automatically when the Bluetooth radio is on.

1. Ensure that Bluetooth is enabled on both devices.
2. Ensure that the Bluetooth device to discover is in discoverable mode.
3. Ensure that the two devices are within 10 m (32.8 ft) of one another.
4. Swipe down from the Status bar to open the Quick Access panel.
5. Touch and hold **Bluetooth**.
6. Touch **Pair new device**. The device begins searching for discoverable Bluetooth devices in the area and displays them under **Available devices**.
7. Scroll through the list and select a device. The Bluetooth pairing request dialog box appears.
8. Touch **Pair** on both devices.
9. The Bluetooth device is added to the **Paired devices** list and a trusted (“paired”) connection is established.

Connecting to a Bluetooth Device

Once paired, connect to a Bluetooth device.

1. Go to **Settings**.
2. Touch **Connected devices > Connection preferences > Bluetooth**.
3. In the list, touch the unconnected Bluetooth device.

When connected, **Connected** appears below the device name.

RFID Operations



NOTE: Tap the Rocket icon  to initiate rapid read.

Access RFID operations for the following:

- Rapid Read - Displays a view of the inventory operation on the reader, including total reads, unique tag count, tag read rate, and read time.
- Inventory - Displays tag details when tag reading begins.
- Locate Tag - Locates a single tag or multiple tags. Can be accessed from the Inventory screen.
- Tag Write - Allows you to write data to specified tags. Can be accessed from the Inventory screen.
- Pre-Filters - Allows you to set filters for tag data. Can be accessed from the Inventory screen.
- RFID Settings - Allows you to configure specific reader and antenna settings. Can be accessed from the Rapid Read and Inventory screens, as well as from Settings.

Rapid Read



NOTE: Tap the Inventory Screen icon  to begin inventory.

The Rapid Read screen displays the following data:

- Total Reads
- Unique tag count
- Read time (mm:ss)
- Tag read rate (tags/sec).

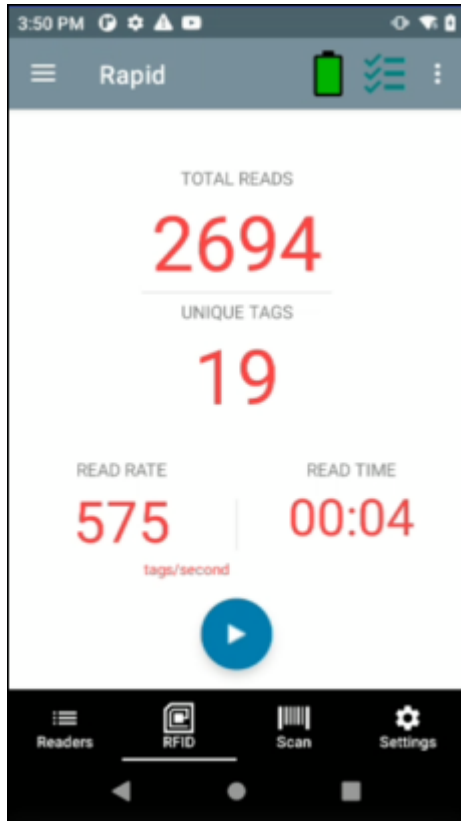

The **Rapid Read** and **Inventory** screens present two different views of the inventory operation on the reader. The **Start/Stop** functionality can be used interchangeably on both screens. For example, when operation starts on the **Rapid Read** screen and you navigate to the **Inventory** screen, the button available on the **Inventory** screen is **Stop**. The same is true when the operation starts on the **Inventory** screen. During the rapid read process, you can navigate to the **Inventory** screen to view tag details along with tag counts for each tag. The statistics displayed are maintained on the **Rapid Read** and **Inventory** screens regardless of the screen used to start the process.

View Rapid Read Results

To view Rapid Read results:

1. Tap **Rapid Read** from the Home or Menu screen.
2. Tap **Start** to start the rapid read inventory operation.
3. Tap **Stop** to stop the inventory operation.



NOTE: The scan trigger on the device can also start and stop the inventory operation. Press the trigger to start, continue to hold and release to stop.

Progressing to another screen does not halt the operation. However, attempting to make changes or perform another operation while rapid read is in process results in an error.

Inventory

Once tags begin reading, the tag details populate the **Inventory** screen. Tag reading starts and stops on this screen as well as on the **Rapid Read** screen. When the process starts, tag information displays on the screen.



NOTE: When the tag does not have printable ASCII data when in ASCII mode, a yellow highlighted background displays on the Inventory screen.

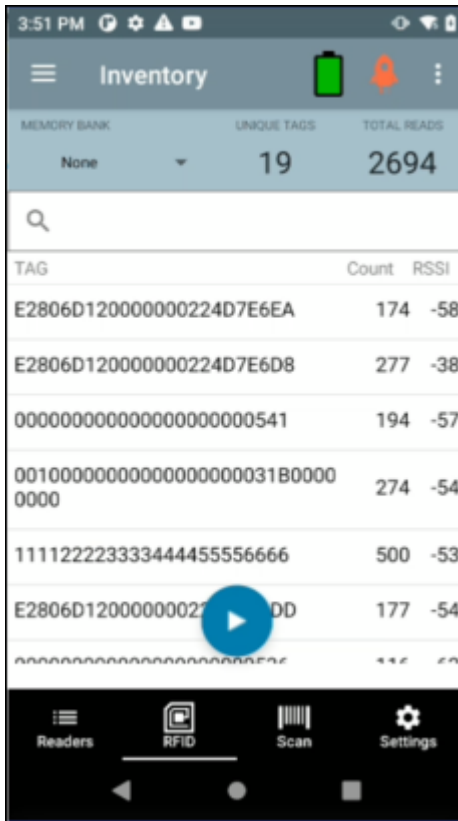

View Inventory Results

To view Inventory results:

1. Tap **Inventory** from the Home or Menu screen.
2. Tap **Start** to start the rapid read inventory operation.
The **Start** button changes to **Stop**.
3. Tap **Stop** to stop the read inventory operation.



NOTE: The scan trigger on the device can also start and stop the inventory operation. Press the trigger to start, continue to hold and release to stop.

4. To filter information by type, tap the Memory Bank dropdown menu and select User, Reserved, TID, or EPC.

5. The tag ID selected can be used to locate, set pre-filters and tag write. After selecting a tag, tap  and select **Locate Tag**, **Pre Filters**, or **Tag Write**.

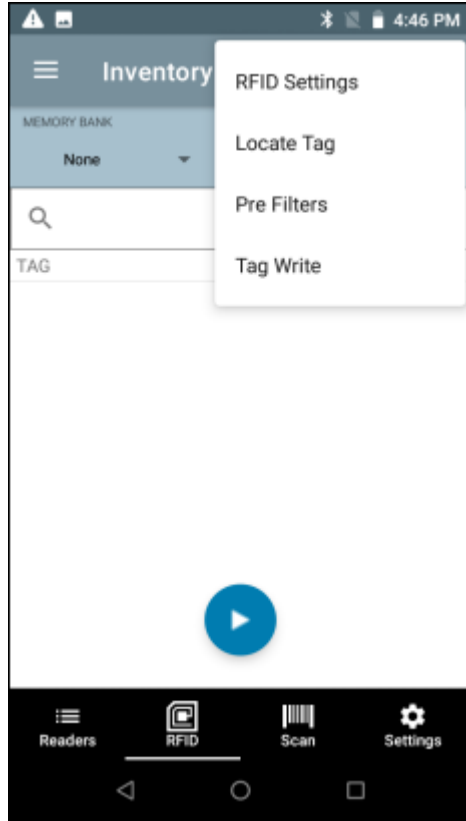

Progressing to another screen does not halt the operation. However, attempting to make changes or perform another operation while this operation is in process results in an error.



NOTE: Tags are fully convertible to ASCII format. ASCII mode may be enabled by selecting **Settings > Application Settings > ASCII Mode**.

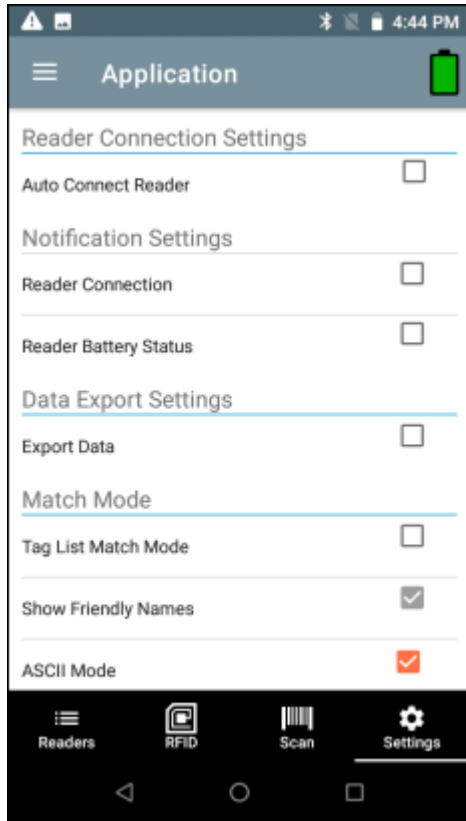

See Also

[Rapid Read](#)

Inventory Screen Features

The following table provides information on various metrics that can be captured using the Inventory feature.

Table 1 Inventory Screen Features

Item	Description
Tags	<p>Tap Memory Bank to select one of the following memory bank options from the drop-down menu:</p> <ul style="list-style-type: none"> • None - Defaults to EPC. • User - Allows reading user memory bank data when the tag is inventoried. • Reserved - Allows reading reserved memory bank data when the tag is inventoried. • TID - Allows reading TID memory bank data when the tag is inventoried. • EPC - Allows reading EPC memory bank data when the tag is inventoried. When the next inventory operation starts, the details from the selected memory bank displays. This menu is inactive if there is an ongoing operation on the connected reader. • Default Display - None.
Search	Tap the Search icon and enter a tag ID. Tags that match the entry display in the content area.
Power Management	Icon indicates if Dynamic Power is on. Tap the Power Management icon to open the Battery Status screen.
Content Area (select a tag)	Tapping a Tag ID highlights the tag. The highlighted Tag ID is populated on the Tag Location text area as well as the Tag Pattern area in the Access Control screen. Tap Start to start searching for the tag. From this screen, return to the Menu or go to the Home screen and select Locate Tag .
Content Area (select a tag)	The tags displayed in this area are based on the option selected from RFID > RFID Advanced Settings > Tag Reporting . Tap the tag ID to expand details about the tag. Tap the tag ID again to collapse details.

123RFID Mobile Application

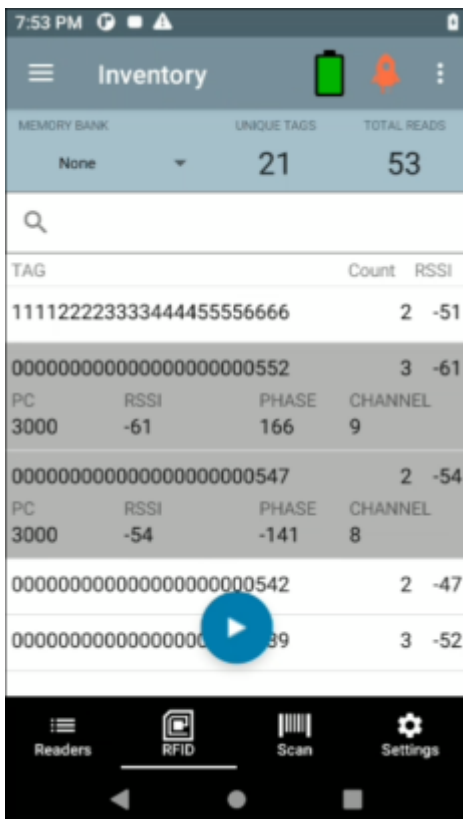
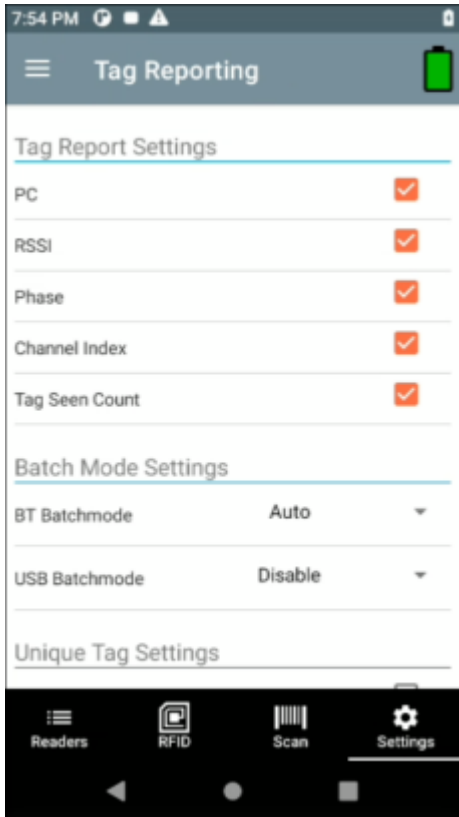

Tag List Match Mode Operation

When **Tag List Match Mode** is checked on the **Application Settings** screen, the application identifies tags from a given set of tags in csv tag list format (comma-separated values file). Browse to choose the csv file. The contents of the csv file displays on the **Inventory** screen. By default, the application displays friendly names from csv files, if **Tag List Match Mode** is enabled. If you do not want to show friendly names, the setting can be disabled in Settings to show only EPC.

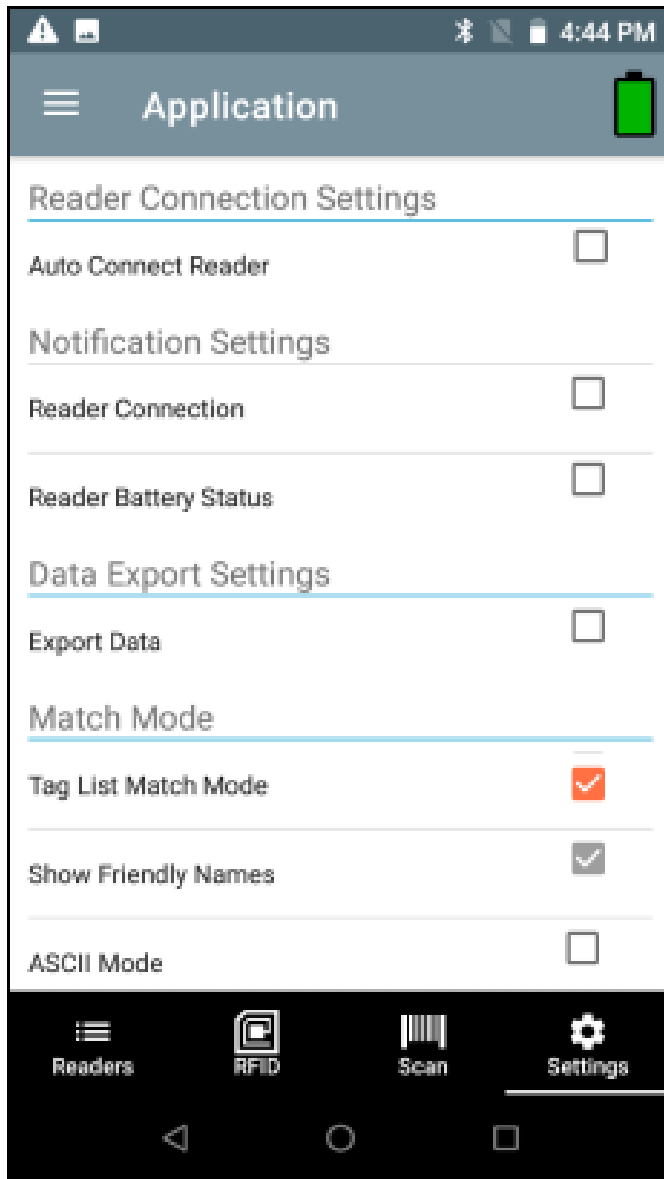

Tag List Color Mode

First, the Brand ID tag will be identified and the tag ID text color changes accordingly. Second, the non-Brand ID tag will be identified and the tag ID text color changes accordingly. Last, if Match Mode = Enable, then the text color changes accordingly to Match, Expected, or Unknown.

Brand ID Tag

- Blue: ASCII = Enable or ASCII = Disable, Tag List Match Mode = Disable.

Normal Tag (Brand ID = Disable)

Read both Brand ID and Non-Brand ID tags

- Black: ASCII = Enable or ASCII = Disable, Tag List Match Mode = Disable

Sample Contents of Taglist.csv File

The csv file should contain only alphanumeric characters in the tag column. If there are any special characters, the row is discarded. When entering data into the **Taglist**, Column A of the csv file should match the EPC tag ID, Column B should include the friendly name or a description of the tag to display when reading.

The following displays a sample **Taglist** csv:

1	E2806890000000014574550D	Sample Tool #1
2	E28068900000000145744E7D	Sample Tool #2
3	E280689000000001457454F3	Sample Tool #3
4	E28068900000000145745520	Sample Tool #4
5	E28068900000000145744E8B	Sample Tool #5
6	E28068900000000145752C7C	Sample Tool #6
7	E280689000000001457549FD	Sample Tool #7
8	E28068900000000145745534	Sample Tool #8
9	E280689000000001457450F0	Sample Tool #9
10	E280689000000001457549C2	Sample Tool #10
11	E280689000000001457452C2	Sample Tool #11
12	E280689000000001457452D5	Sample Tool #12
13	E28068900000000145752C69	Sample Tool #13
14	E280689000000001457610BD	Sample Tool #14
15	E28068900000000145745295	Sample Tool #15
16	E280689000000001457610CD	Sample Tool #16
17	E2806890000000014575476C	Sample Tool #17
18	E28068900000000145754745	Sample Tool #18
19	E28068900000000145754758	Sample Tool #19
20	E28068900000000145752EE6	Sample Tool #20
21	E28068900000000145752C55	Sample Tool #21
22	E2806890000000014574534D	Sample Tool #22
23	E28068900000000145754780	Sample Tool #23
24	E28068900000000145752EA2	Sample Tool #24
25	E28068900000000145752ECA	Sample Tool #25
26	E28068900000000145752EB6	Sample Tool #26
27	E280689000000001457549EA	Sample Tool #27
28	E280689000000001457549D6	Sample Tool #28
29	E28068900000000145745103	Sample Tool #29
30	E28068900000000145744E9A	Sample Tool #30

Before the inventory starts, the count is zero. After the inventory starts, the tag list is imported into either the inventory or **RapidRead** screen. The tag list can be sorted using the menu choices. Select an option to display the type of tags to show when the inventory starts.

If **Tag List Match Mode** is enabled, the text color changes accordingly:

- Matching = Green
- Missing/Expected = Red
- Unknown = Gray

Sample 1 Inventory List: Tag List Enabled; Matching Tag Option Selected

When inventory starts, the application only displays the tag reads that match the tags in the taglist.csv file. Matching tags display in green. Select any tag read to show the matching tag details in the csv file.

Sample 2 Inventory List: Tag List Enabled, Missed Tag Option Selected

When inventory starts, the application only displays the tag reads that are missed and included in the taglist.csv file. Missed tags display in red. Select any tag to show the missed tag details in the csv file.

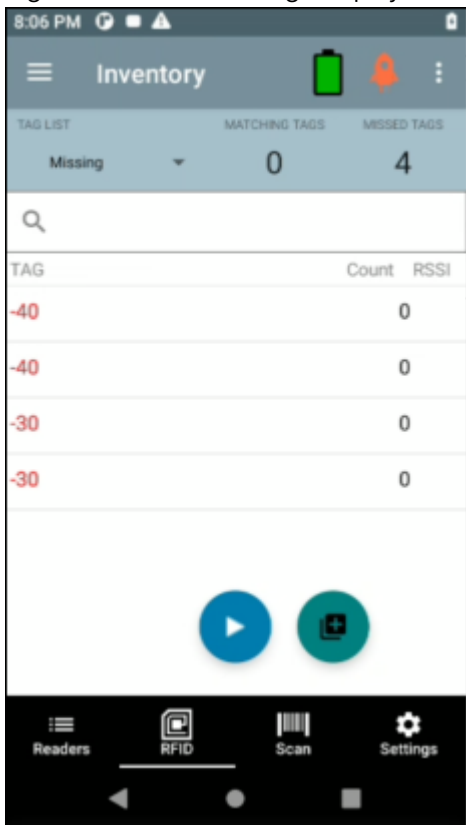

Sample 3 Inventory List: Tag List Enabled, Unknown Tag Option Selected

When inventory starts, the application only displays tags that were read but not included in the taglist.csv file, Unknown tags display in gray. Select any tag to show the unknown tag details.

Sample 4 Inventory List: Tag List Enabled, All Tag Option Selected

When inventory starts, the application displays the tags for all the options:

- Tag reads that match the tags in the taglist.csv file. Matching tags display in green. Select any tag read to show the matching tag details in the csv file.
- Tag reads that are missed and included in the taglist.csv file. Missed tags display in red. Select any tag to show the missed tag details in the csv file.
- Tags that were read but not included in the taglist.csv file. Unknown tags display in gray. Select any tag to show the unknown tag details.

Sample 5 Tag List Matching Selected; Show Friendly Names

When inventory starts, the application displays the tags for selected options from All, Matching, Missing, or Unknown. Application shows friendly names (i.e. Tag details instead of EPC) on screen.

Sample 6 Exporting Data - Tag List Matching Selected

The application settings screen has the option to Export Data. If the option is checked, data is exported when the inventory stops. The tag content area is exportable to a file. For example, when **Matching** is selected from the menu to display only matching tags in the tag content area, the matching data can be exported to a file. The exported csv file includes the matching, missing, and unknown tag count.

Unique Tag Reporting

When **Report Unique Tags** is enabled on the Tag Reporting screen, the reader reports unique tags based on the options below.



NOTE: The reader beeps when a unique tag is observed.

- When the **Matching** option is selected (See **Sample 1 Inventory List: Tag List Enabled; Matching Tag Option Selected**) the tag count cannot exceed one because the unique tags are only reported once.
- When the **Matching** option is not selected, the list displays unique and total reads. The tag count cannot exceed one because the unique tags are only reported once.

To export data, from the bottom navigation bar, tap **Settings > Application** and enable **Export Data** or tap **☰ > Settings > Application** and enable **Export Data**.

Exported files are saved under /sdcard/inventory/RFID_2022-01-24_15-59-38.131.csv

Each exported file is named using the date and timestamp.

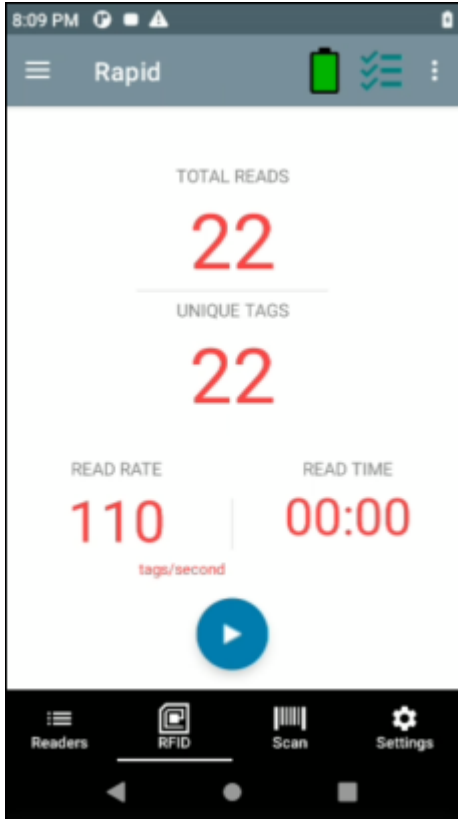

NXP BrandID Check

When **Check BrandID** is enabled on the Tag Reporting screen, the reader reports only tags based on the brand options below.

- Brand ID
- EPC Length

After enabling the **Check BrandID** settings, you can start the inventory. If the tag has a matching brand ID, the inventory list displays tag data in blue.

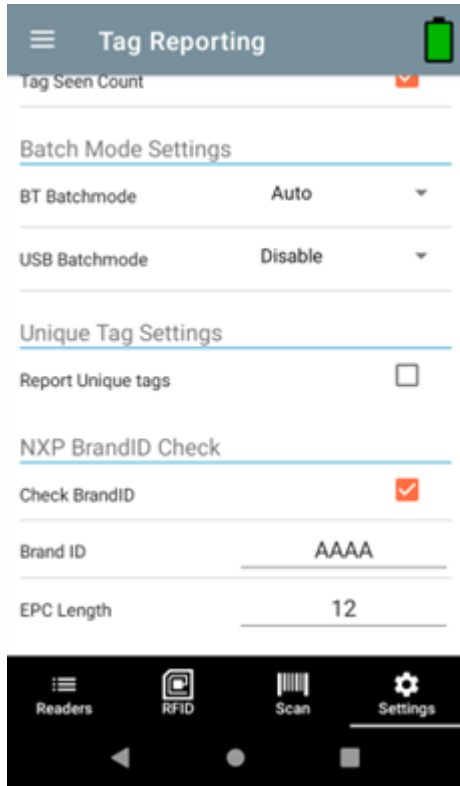

Locate Tag

Use Locate Tag to locate a single tag or multiple tags (Multi Tag). From the Inventory screen, tap  and select **Locate Tag**.

Locate a Single Tag

To locate a single tag:

1. Tap **Locate Tag** from the **Home** or **Menu** screen.
2. Enter the Tag ID in the text area or select a tag from the Inventory screen to pre-populate the Tag ID to search.
3. Tap **Start** to start the locate tag operation.
4. Tap **Stop** to stop the locate tag operation.



NOTE: The scan trigger on the device can also start and stop the locate tag operation. Press the trigger to start, continue to hold and release to stop.

The **Locate Tag** screen displays a color bar graph showing the proximity percentage (relative distance) of the tag. The percentage provides the relative distance from 0% to 100% where the tag is. The higher the percentage, the closer the tag is to the scanner.

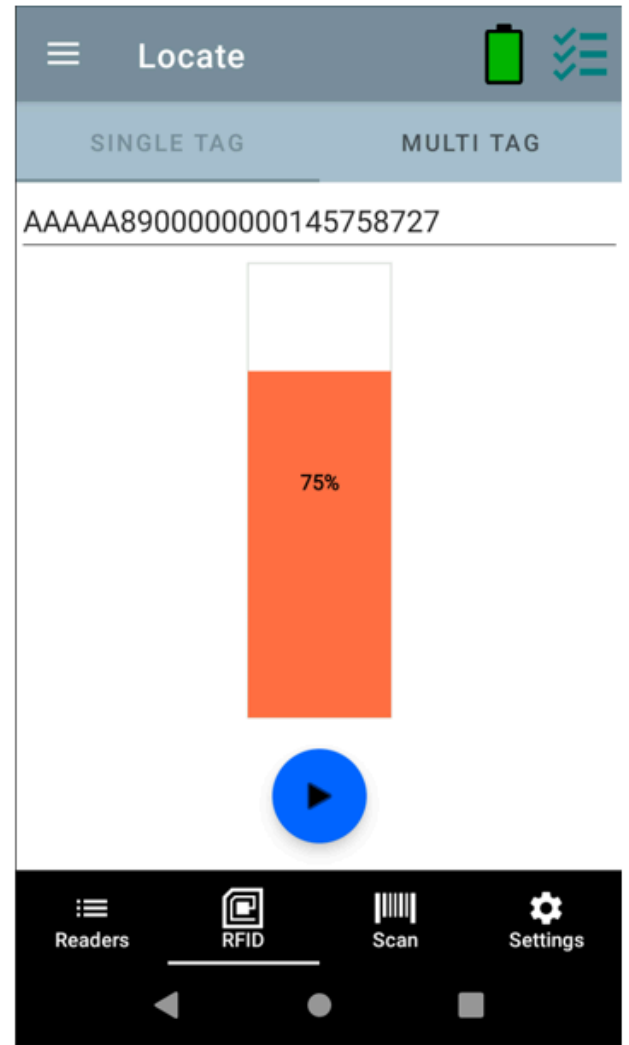
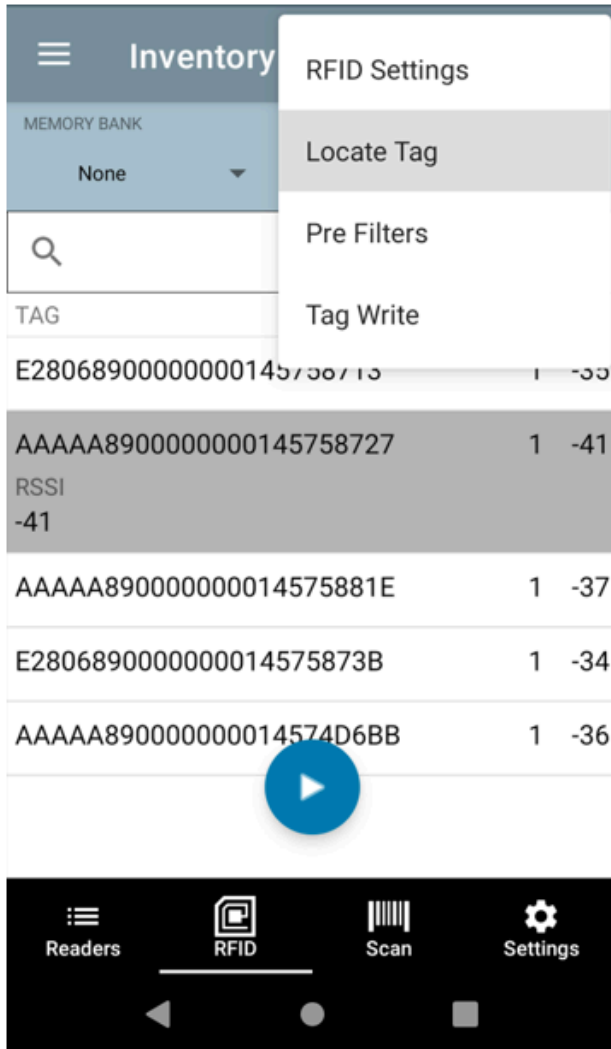

Progressing to another screen does not halt the operation, until **Stop** is selected. However, attempting to make changes or perform another operation while the locate tag operation is in process results in an error.

Locate Multiple Tags (Multi Tag)

Locate multiple tags by importing a csv file.



NOTE: Multi Tag Locate supports ASCII mode. Enable ASCII mode from **Settings > Application > Global Settings > Enable ASCII Mode**.

To locate and track multiple tags:

1. Tap **Locate Tag** from the Home or Menu screen.
2. Select the **Import csv file** on the Multi Tag panel.
The csv file holds the EPC ID and RSSI value. The default RSSI for the EPC will be -33.
3. Select the file containing the specific tag information from the file manager to bring the file into the application.
4. Tap the **Reset Data** icon to reset the tag count and RSSI proximity %.

5. Tap the **Add Tag ID** icon to add the EPC value of interest to the dynamic list of EPC's. It can only add the value which is present in the imported csv file.
6. Tap the **Remove Tag ID** icon to remove the EPC value of non-interest from the dynamic list of EPC's. It can only remove the value which is present in the csv file.



NOTE: Once you re-access the **MultiTag Locate** screen, the entire tag list from the csv file displays, if values were deleted dynamically.



Basic Pre Filters

1. From the **Inventory** screen, tap  and select **Pre Filters**.
2. Select **Basic**.
3. Slide the **Offset** and **Length** to select the different portions of the tag to filter from while performing an inventory.

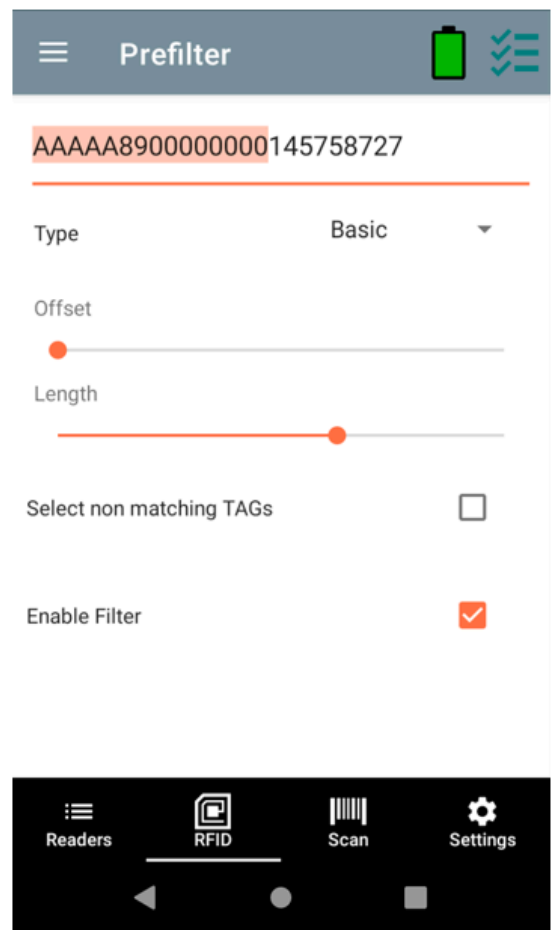
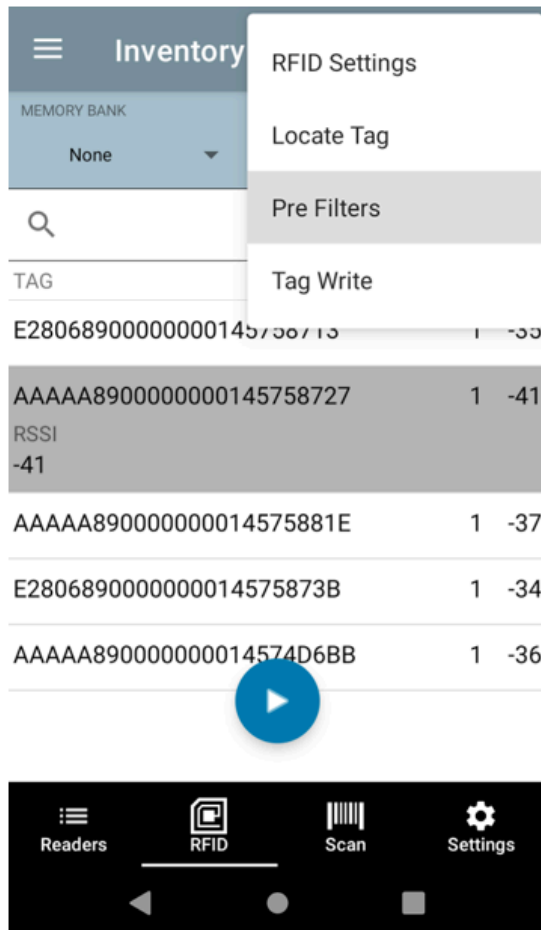
4. Select **Enable Filter**.

Tag Write

1. From the Inventory screen, tap  and select **Tag Write**.
2. Select **Read/Write tags**

Read/Write

The Tag Pattern area is automatically filled in when a tag is selected in the Inventory screen. The Read/Write access operation is simplified with offset and length fields are hidden. The user can tap the more/advanced options icon to see offset and length fields. Tap the icon again to hide the advanced options.

Memory Bank options now have extended menu options to choose directly interested area of memory bank. This avoids typing of offset and length etc.



NOTE: SDK 2.0.49 enabled with the Write + 1 retry feature, improves the efficiency during the Tag Write operation.

Read/Write options are:

- **Tag ID and Password** values are in hex. Tag ID is edited.

- **Memory Bank options** - EPC, TID, USER, PC and CRC, Access Password, Kill Password.
- **Offset** and **Length** values are in 16-bit words. This is only available after tapping the **Advanced Options** icon. To toggle visibility, tap **Advanced Options** again.
- **Access operation** screen maintains edited tag ID.



NOTE: The user can read/write to/from tags in ASCII mode.

Figure 1 Read/Write Basic

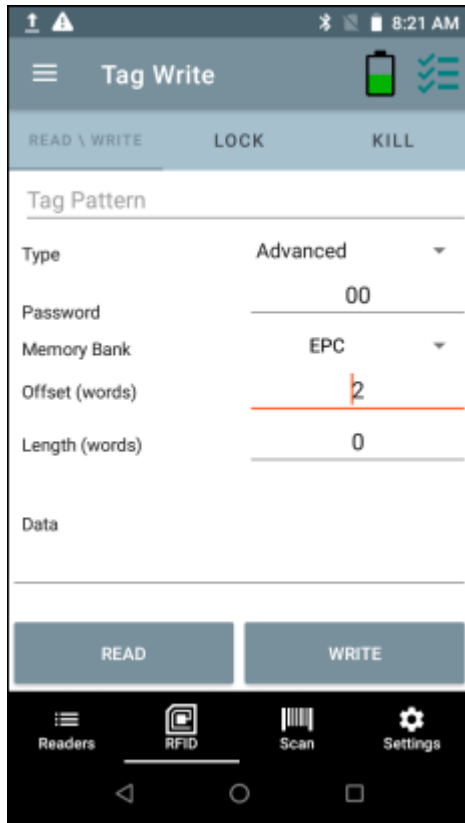

Figure 2 Read/Write Advanced

Lock



NOTE: U9 NXP tags are not supported.

Lock privilege options are as follows:

- Read and Write
- Permanent Lock
- Permanent Unlock
- Unlock

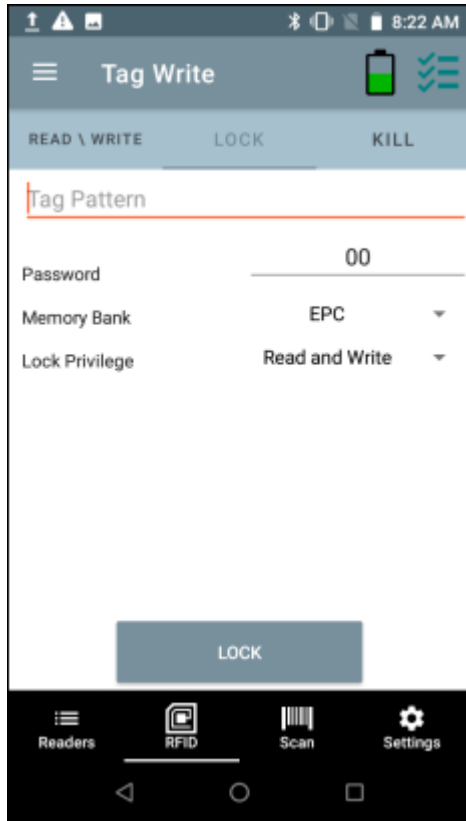

Kill

Permanently renders the tag unusable. A **Kill Password** must be provided.



Settings

To access Settings, tap **Settings** from the bottom navigation bar or tap **☰** > **Settings**. Settings are divided into four types:

- **General** - allows you to configure settings on the device.
- **RFID** - allows you to configure specific reader and antenna settings.
- **Application** - allows you to make changes to the 123RFID Mobile Application settings.
- **SCAN** - allows you to configure settings for the scanner.

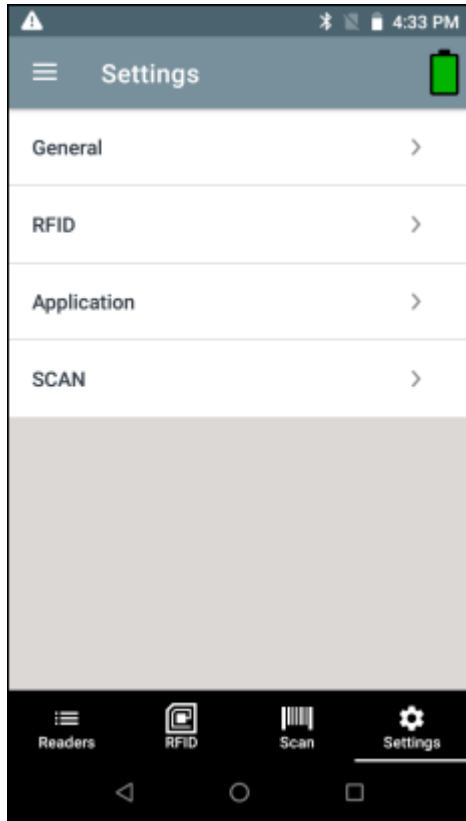

See Also

- [General Settings](#)
- [RFID Settings](#)
- [Application Settings](#)
- [Scan Settings](#)

General Settings

To access General Settings, from the bottom navigation bar, tap **Settings** > **General** or tap **☰** > **Settings** > **General**.

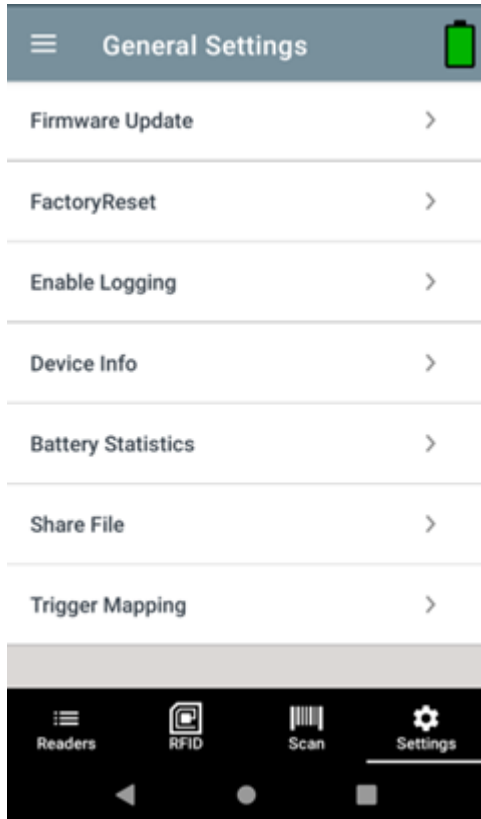

The General Settings screen options include:

- **Firmware Update** - Update the firmware on the reader.
- **Factory Reset** - Reset file settings on the reader to factory defaults.
- **Enable Logging** - Enable the logging of tag reads.
- **Device Info** - View information such as friendly name, serial number, and RFID/scan settings.
- **Battery Settings** - View Information about Battery, such as Manufacturing Date, Battery Model, Battery ID, State of Health, Charge Cycles, Battery Temperature.
- **Share File** - Share a file with a paired device.
- **Trigger Mapping** - Change the mapping for the upper and lower trigger and designate the Upper Trigger for RFID decode and the Lower Trigger for Host Scan or the Upper Trigger for Host Scan and the Lower Trigger for RFID decode.



NOTE: Tap the battery icon in the top right corner of the screen to view battery statistics.

See Also

[Firmware Update](#)
[Factory Reset](#)
[Enable Logging](#)
[Device Info](#)
[Battery Statistics](#)
[Share File](#)

Trigger Mapping

Update the Device Firmware

To update device firmware:

1. Tap Update Firmware.

Go to zebra.com/support to download the latest firmware.

2. Ensure that the terminal is connected to the device.

3. Copy the .DAT file to /SD card/.

Do not use the folder shortcut.

4. To access Firmware Update, from the bottom navigation bar, tap **Settings > General > Firmware Update** or tap **☰ > Settings > General > Firmware Update**.

5. Select the firmware version to be loaded onto the device.

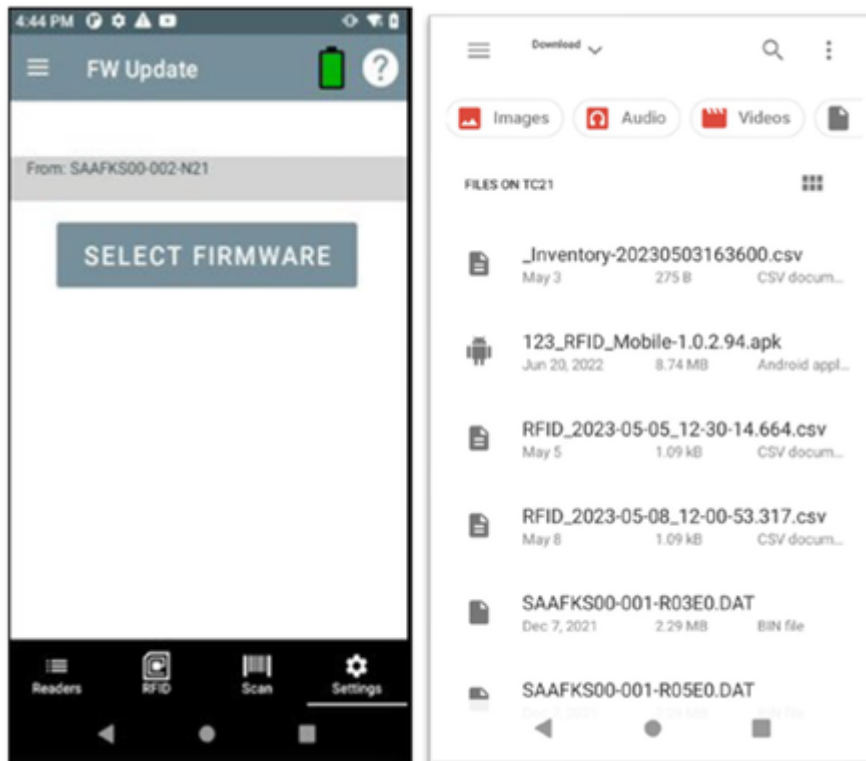

- 6. When selecting EDAT file, enter the password that was used to generate the encrypted offline package using 123RFID Desktop.



- The update path displays starting from firmware to newly selected version. The update percentage increases as the sled device updates.

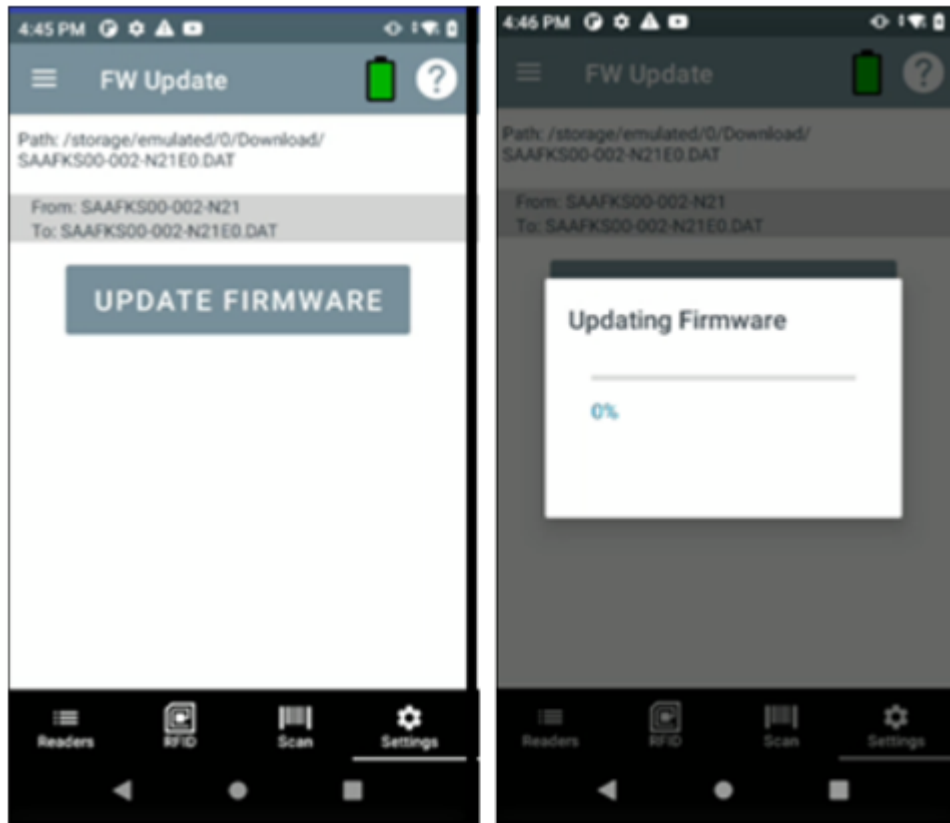

Factory Reset

Performing a factory reset clears any saved settings and restarts the reader. The region needs to be set again.

- To reset to factory defaults, from the bottom navigation bar, tap **Settings** > **General** > **Factory Reset** or tap **☰** > **Settings** > **General** > **Factory Reset**.

2. Select one of the following:

a) **FactoryReset** to perform a factory reset.

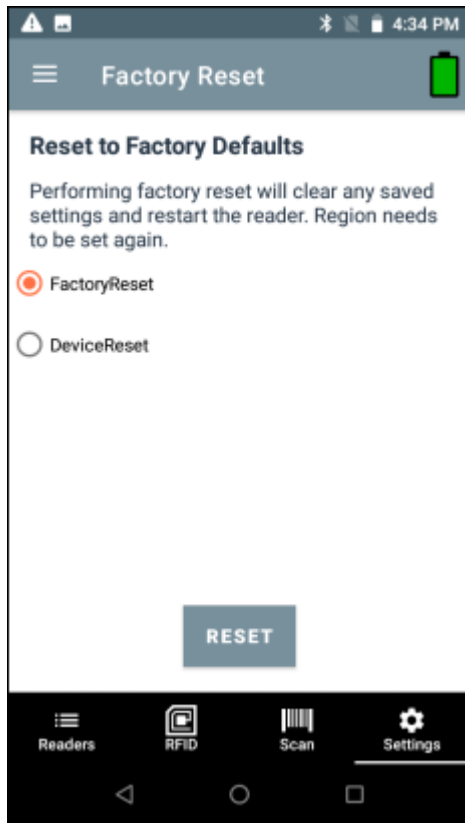

b) **DeviceReset** to perform a device reset, which reboots the device.

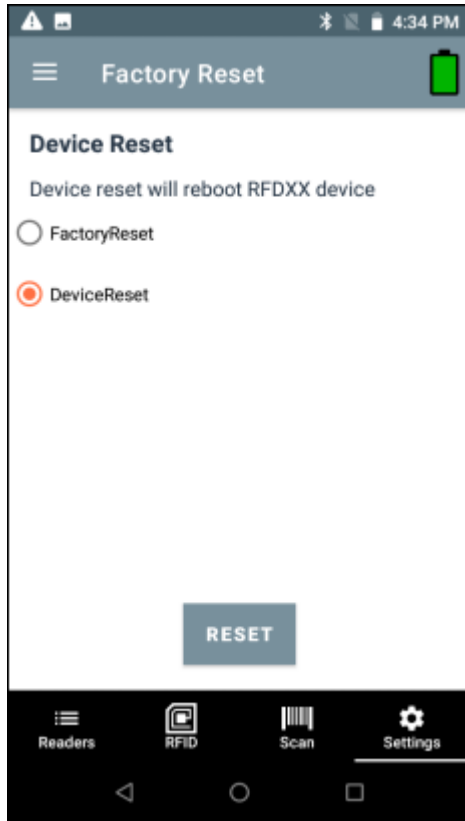

3. Tap **RESET**.

Enable Logging

1. To enable logging, from the bottom navigation bar, tap **Settings > General > Enable Logging** or tap **☰ > Settings > General > Enable Logging**. All the enabled logs are captured in logcat which can be retrieved through RxLogger.

2. Specify the following:

- Tap **Enable real time Logs** to toggle on or off.
- Tap **Enable NGE Error Logs** to select.
- Tap **Enable NGE Event Logs** to select.
- Tap **NGE packet Logs** to select.
- Tap **RETRIEVE LOGS FROM RAM** or **RETRIEVE LOGS FROM FLASH**.
- Tap **Enable Debug logs** to toggle on or off.

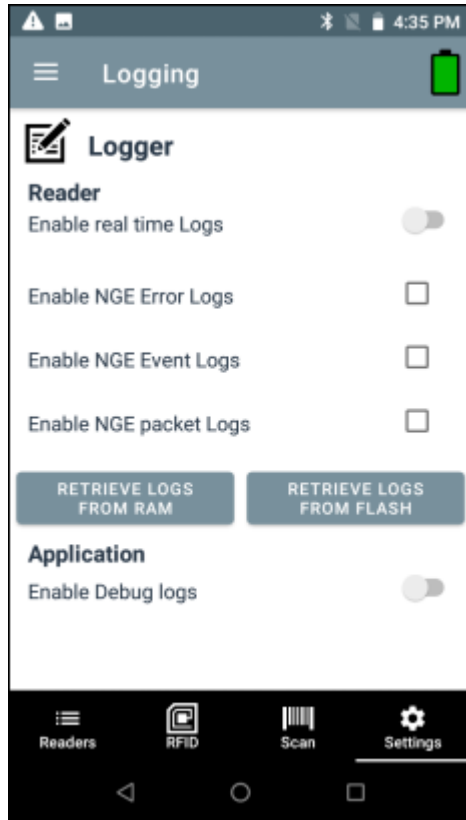

Device Info

To access Device Info, from the bottom navigation bar, tap **Settings > General > Device Info** or tap **☰ > Settings > General > Device Info**.

Device Info displays the following:

- Model Number
- Serial Number
- Firmware
- RFID Radio
- Manufacture Date
- Application Version

- SDK Version

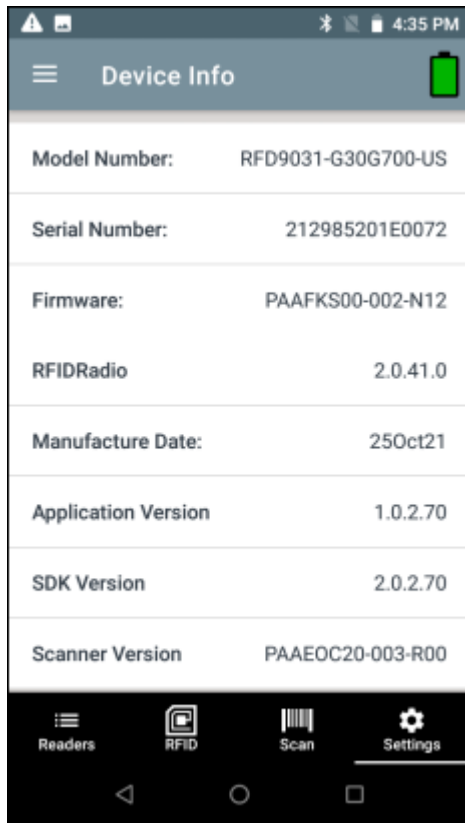

Share File

1. To share a file, from the bottom navigation bar, tap **Settings > General > Share File** or tap **☰ > Settings > General > Share File**.

File Explorer opens.

2. Select a single file or multiple files.

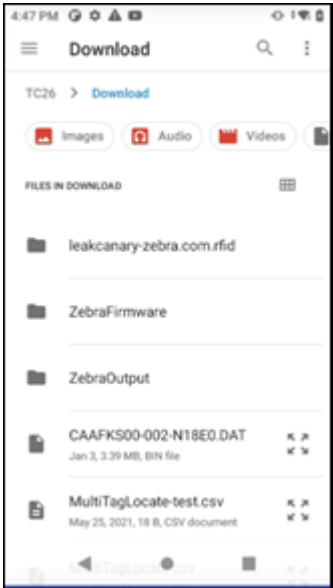

User has an option to share the file(s) to a nearby device via Bluetooth or any other file sharing supported app.

3. Select from the provided options.

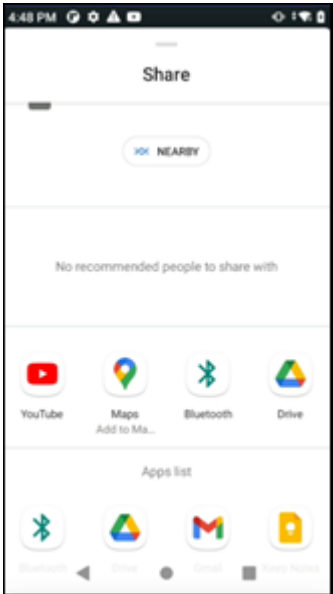

Trigger Mapping

To map a trigger:

1. Tap **Settings** > **General** > **Trigger Mapping** or tap **☰** > **Settings** > **General** > **Trigger Mapping**.

2. Select one of the following options for each trigger:
 - RFID Start/Stop - start and stop RFID decode operations.
 - Sled Scanner - barcode decode from the sled.
 - Terminal Scanner - barcode decode from the mobile computer. Feature support is determined by the mobile computer being used with the sled.
 - Scan Notification - scan trigger press notification.
 - No Action - No action when the trigger is pressed.

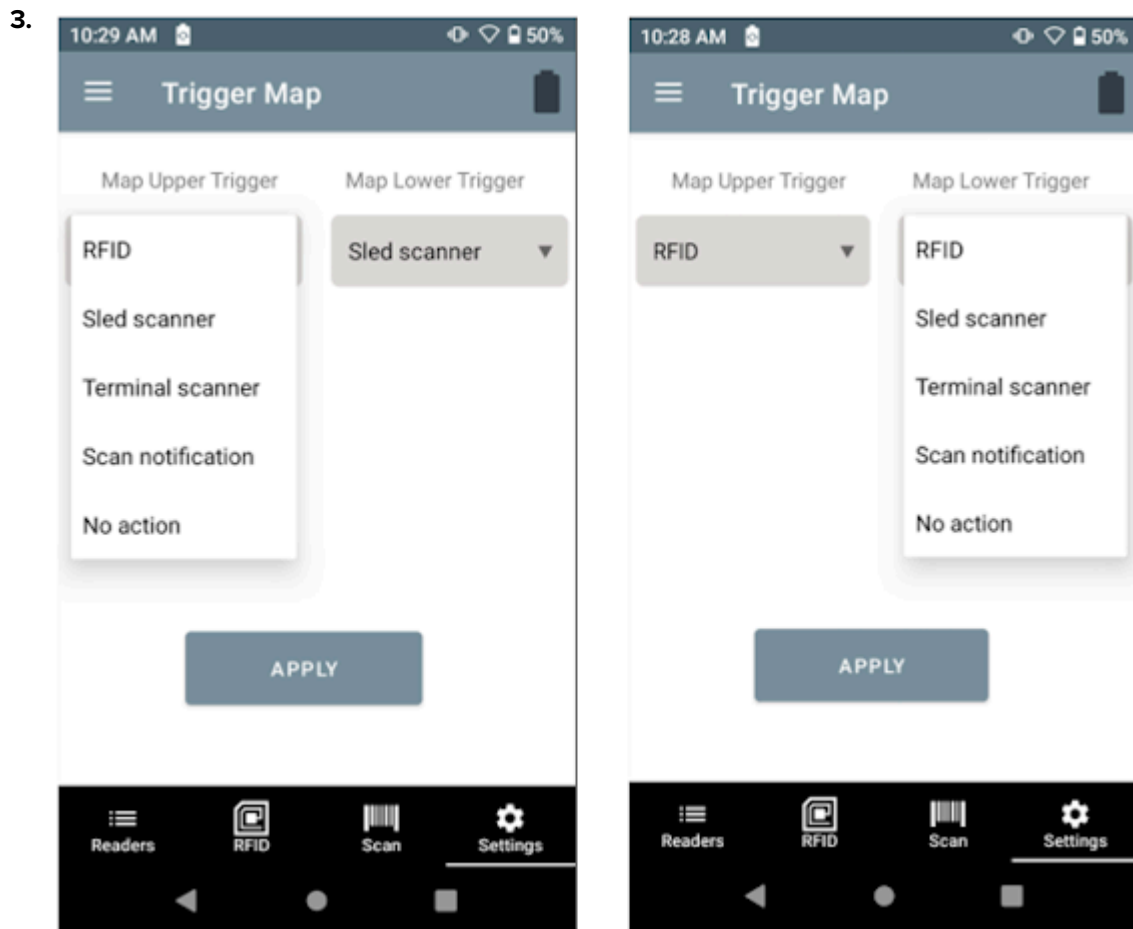

Configuring WLAN Settings

Configure WLAN settings and status using 123RFID Mobile.

Access WLAN Settings from the bottom navigation bar by tapping **Settings > WIFI**.

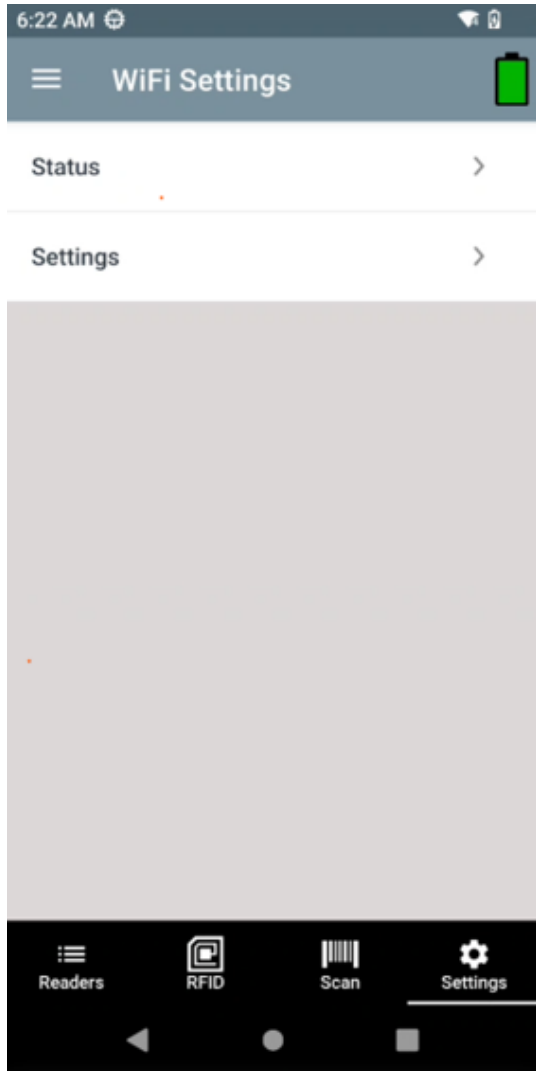

Wi-Fi Status - provides the current reader status for the Wi-Fi connection state, enables channel bands, and connection details when connected.

Select Channel List Band

- Tap 2.4GHz to enable/disable the 2.4GHz channel.
- Tap 5GHz NON DFS to enable/disable the 5GHz NON DFS channel.
- Tap 5GHz DFS to enable/disable the 5GHz DFS channel.

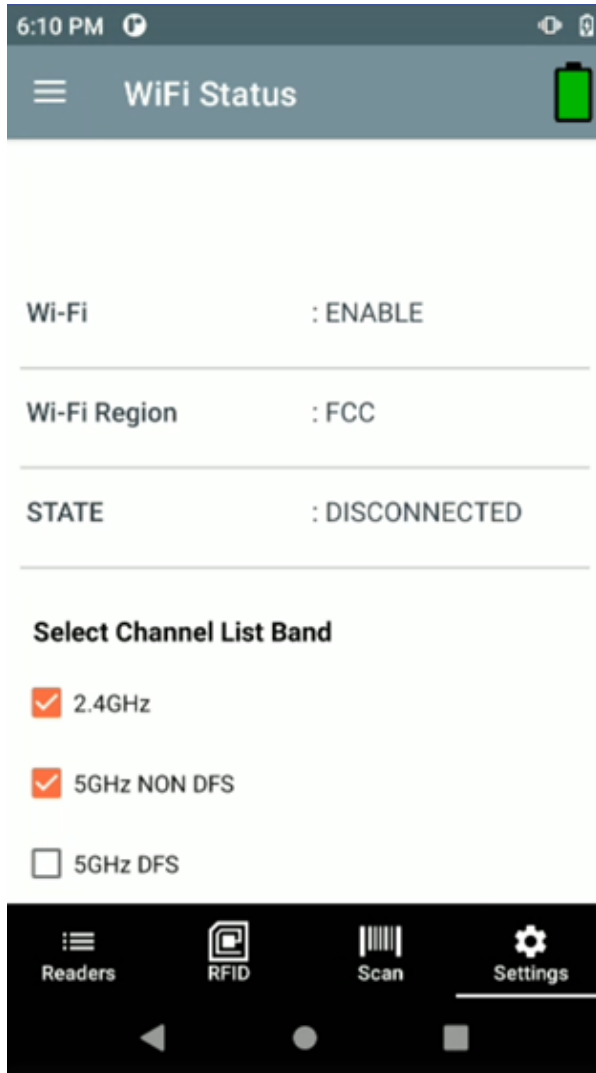

Wi-Fi Settings - initiates Wi-Fi scanning and lists available SSIDs.

- 1. After scanning is complete, observe the available SSIDs listed.

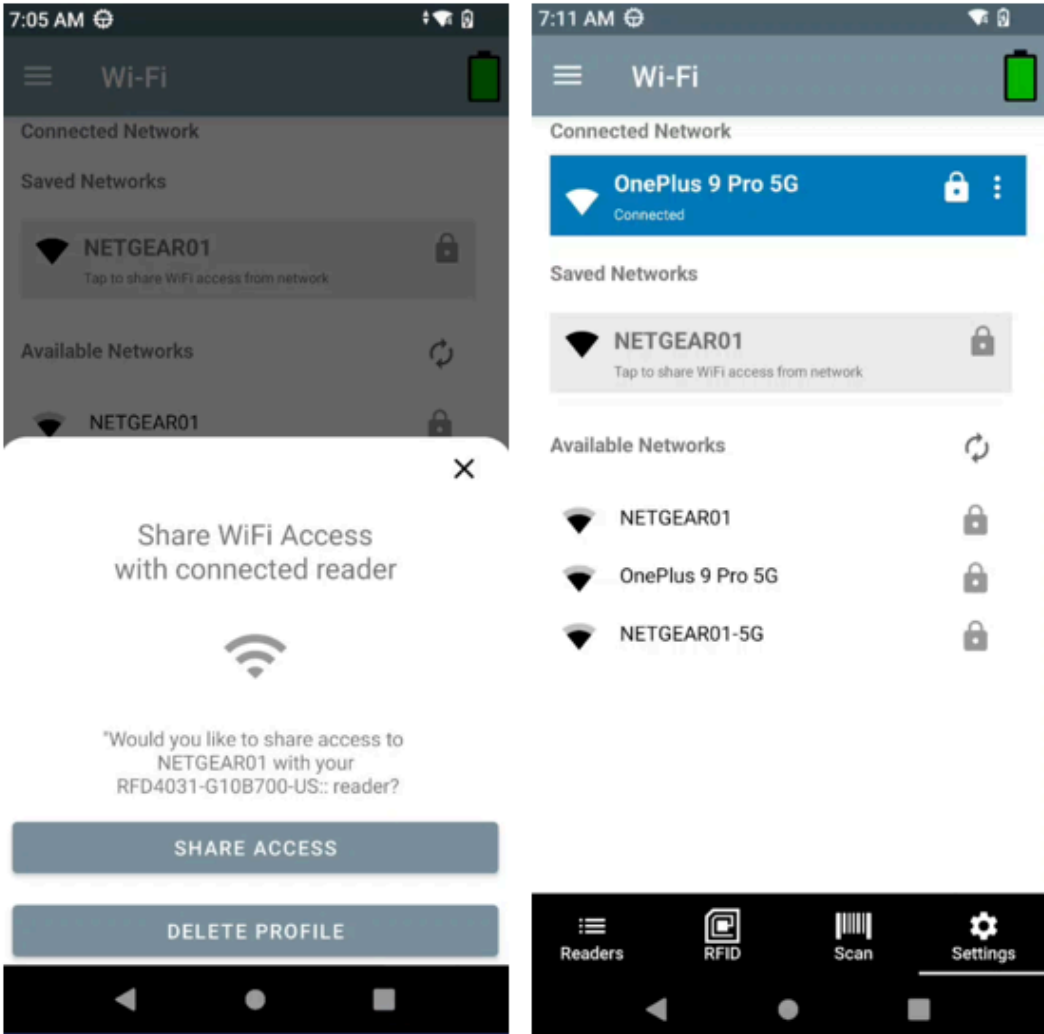

2. Create a WLAN profile for the selected SSID and save it to the reader.

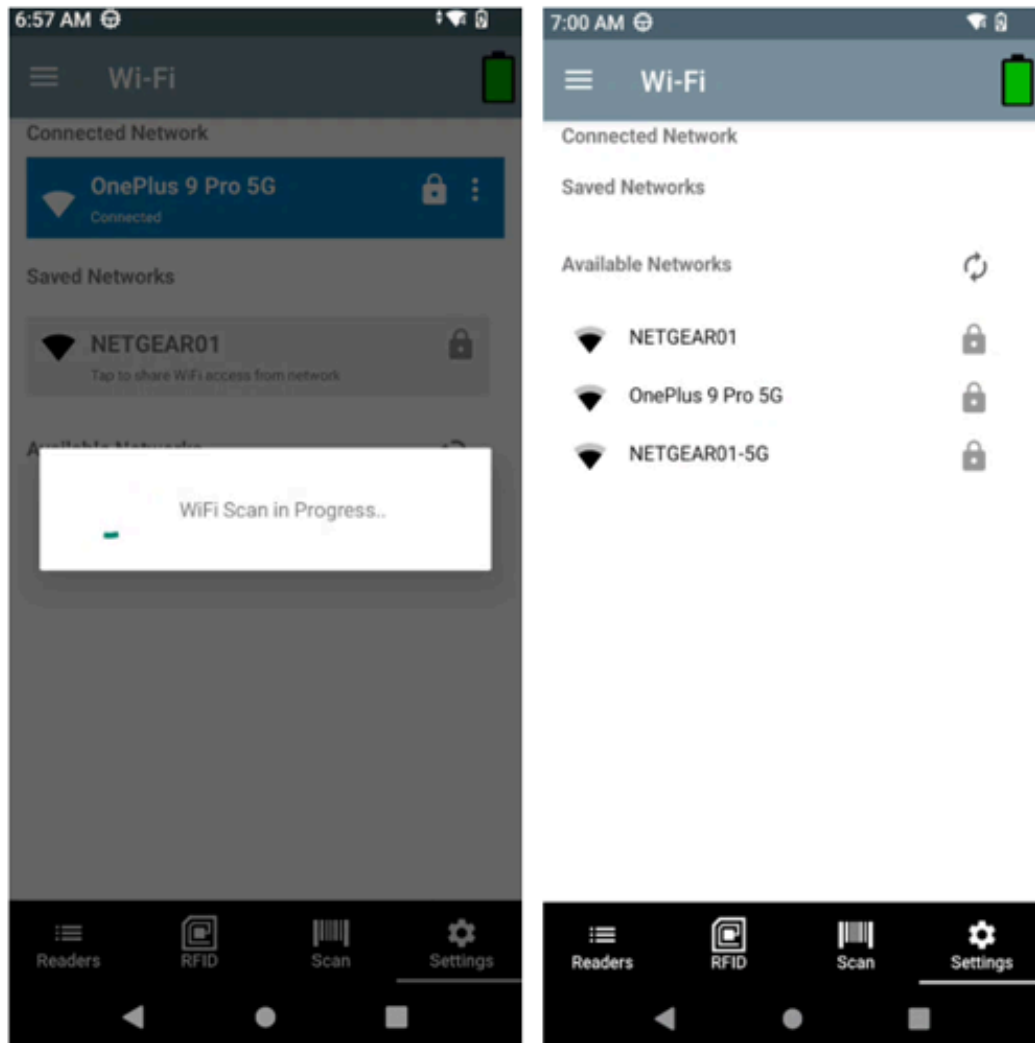

Observe the saved profile is listed in the **Saved Networks** section.



3. Tap the WLAN profile list to connect to the saved profile.

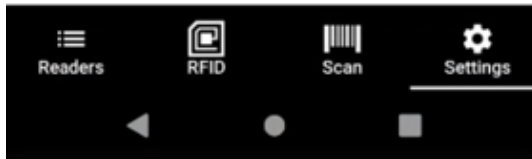

- Tap **Share Access** to connect to the WLAN profile.
- Tap **Delete Profile** to delete the saved profile from **Saved Networks**.

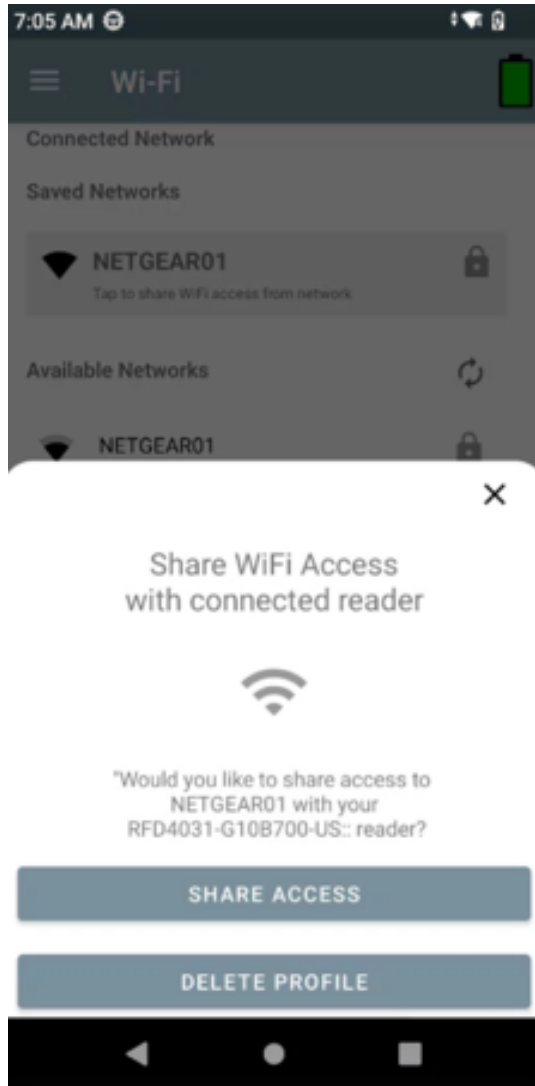

Creating a WPA Profile

Create and configure a personal or enterprise WPA profile by selecting its protocol, authentication network, certificate, and autonomous identity.

123RFID Mobile supports the following profile configurations:

- WPA Personal
- WPA2 Personal
- WPA2 Enterprise
- WPA3 Enterprise



NOTE: The certificate must be installed on the reader using 123RFID Desktop.

Configure the following fields to create a WPA/WPA2 personal profile.

1. Select the protocol.

2. Enter the password.

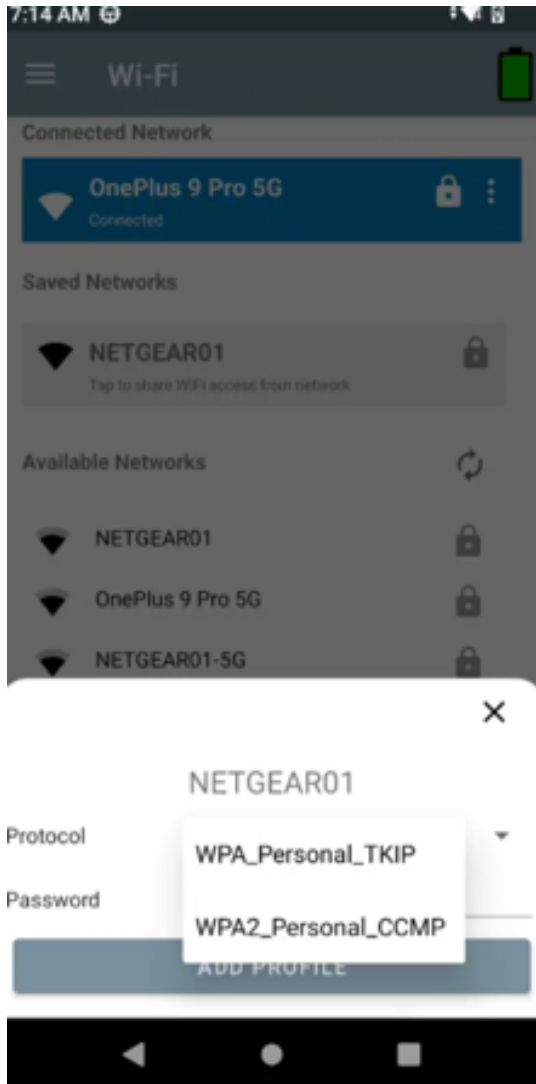

Configure the following fields to create a WPA/WPA2 personal profile.

1. Select the protocol.
2. Select the Extended Authentication Framework.
3. Select the CA certificate.
4. Enter an Identity (optional).
5. Enter an Autonomous Identity.
6. Enter the password.

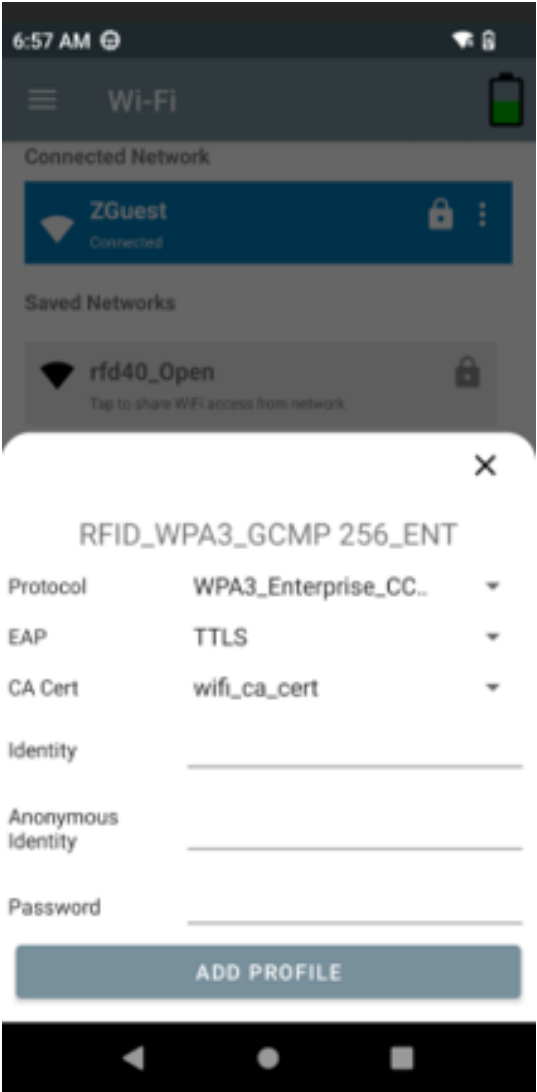

Navigate to the reader WiFi settings using the **Connected Readers** menu.

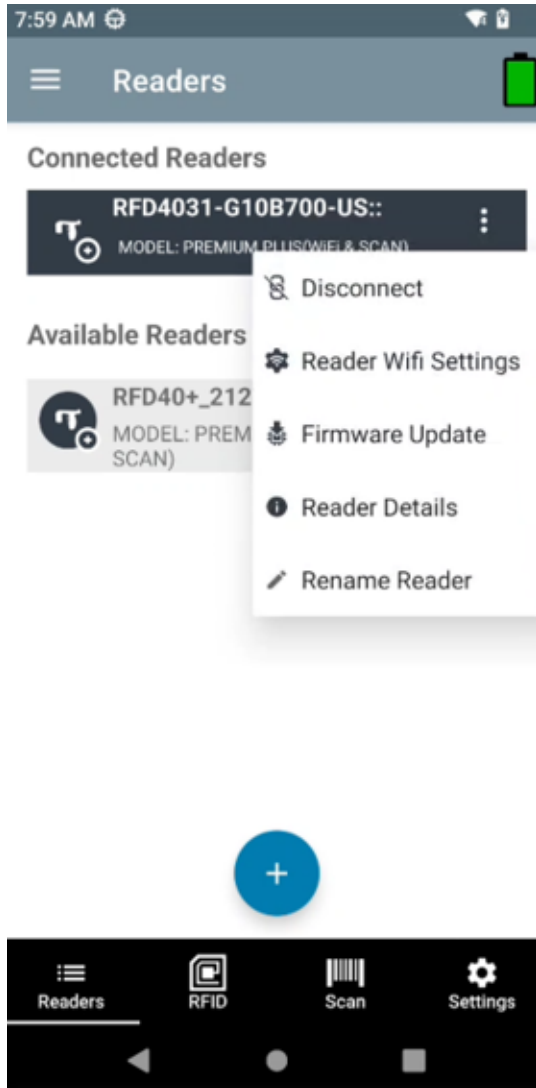

RFID Settings

To access RFID Settings from the bottom navigation bar, tap **Settings** > **RFID** or tap **☰** > **Settings** > **RFID** or from the Rapid Read or Inventory screens, tap **☰** > **RFID Settings**.

RFID Settings include:

- **Profiles** - Displays **Fastest Read**, **Cycle Count**, **Dense Readers**, **Optimal Battery**, **Balanced Performance**, **User Defined** and **Reader Defined** profiles.
- **Advanced Reader Settings** - Antenna, Singulation Control, Start/Stop Triggers, Tag Reporting, Power Management, and Save Configuration.
- **Regulatory** - Allows selection of region and available channels.
- **Beeper** - Provides the option to change the volume of both the host and sled device.
- **LED** - Enables or disables Terminal/Host tag read LED for inventory indications.
- **Charge Terminal** - Enables or disables charging the mobile device using the I/O pins on the adaptor.

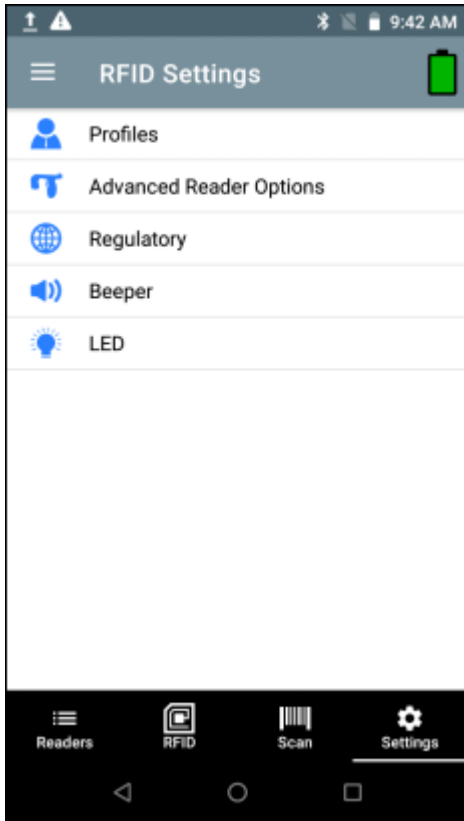

Profiles

To display the list of profiles, from the bottom navigation bar, tap **Settings > RFID > Profiles**.

- The currently selected profile is highlighted in orange.
- Tap a profile item to expand the profile and view applicable configurations.
- Profiles can be selected or disabled by using the slider switch to the right of the profile name.



NOTE: If Power Level, Link Profile, Session, or Dynamic Power are modified from each respective screen, then the currently selected profile changes to User Defined profile, and profile item values are modified with the same values.

Profile setting options include:

- Fastest Read - Read as many tags as fast as possible.



NOTE: By default, the fastest read profile is selected and configures the reader for the maximum power level allowed based on the read profile. However, the dBm can be limited due to the regulatory requirements of the specified region in which the sled is being used.

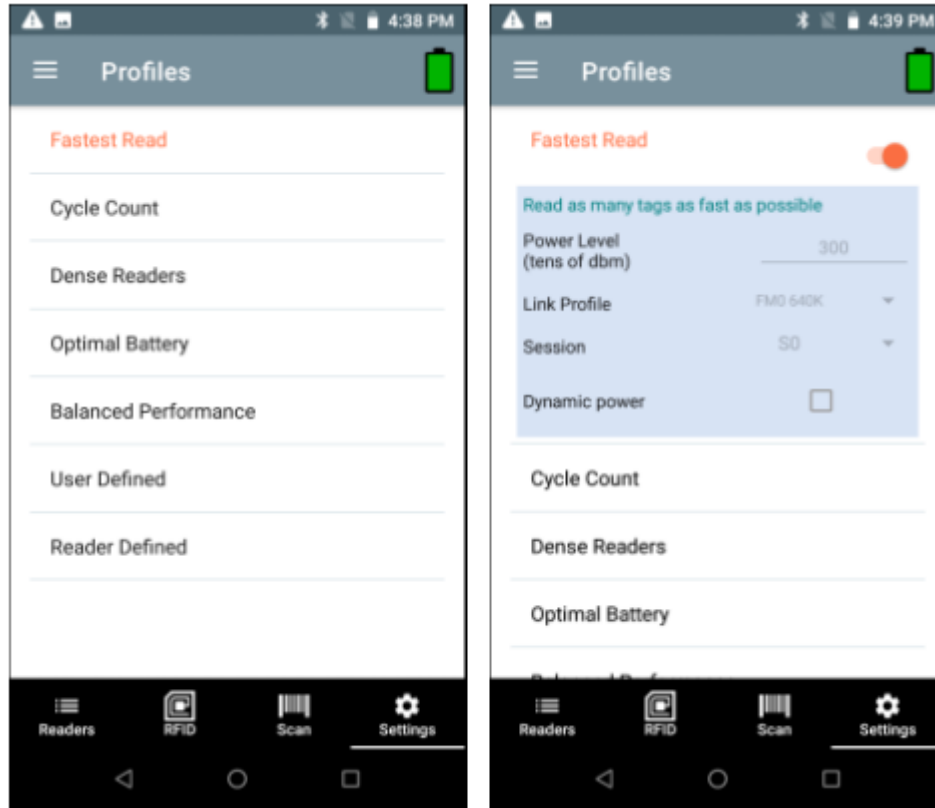

- Cycle Count - Read as many unique tags as possible.

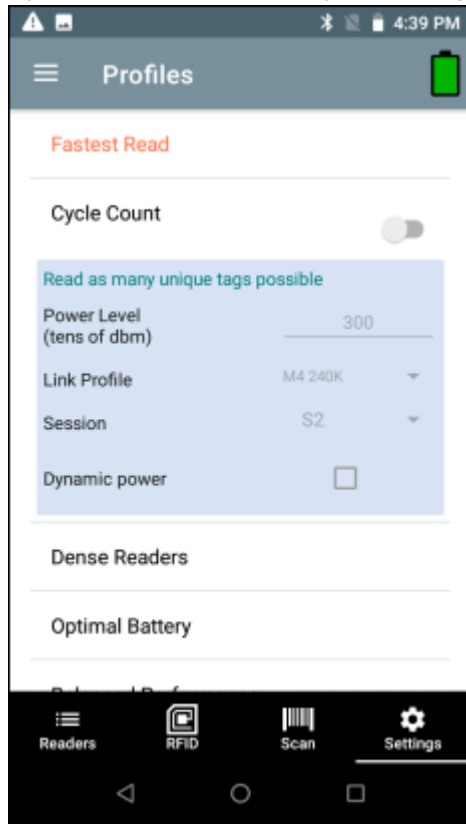

NOTE: This profile uses a Singulation S2 setting that puts tags to sleep for a period of time, so the application can focus on unseen tags. use caution when using this profile.

- Dense Readers - Use when there are multiple readers within close proximity.

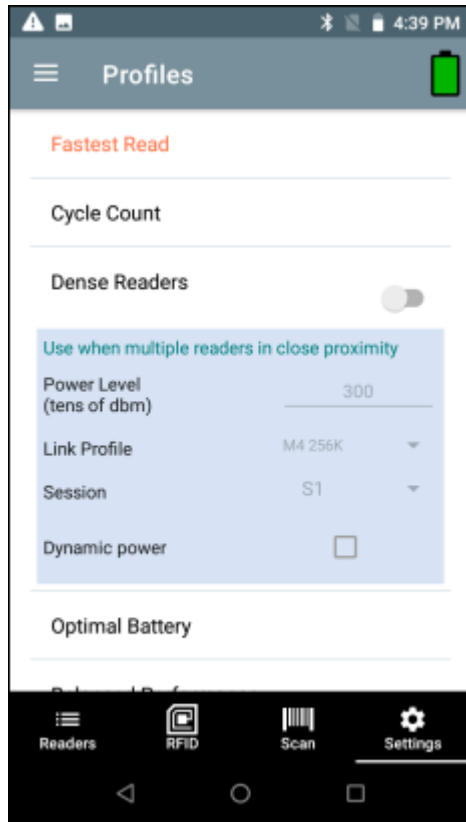

- Optimal Battery - Provides optimal battery life.

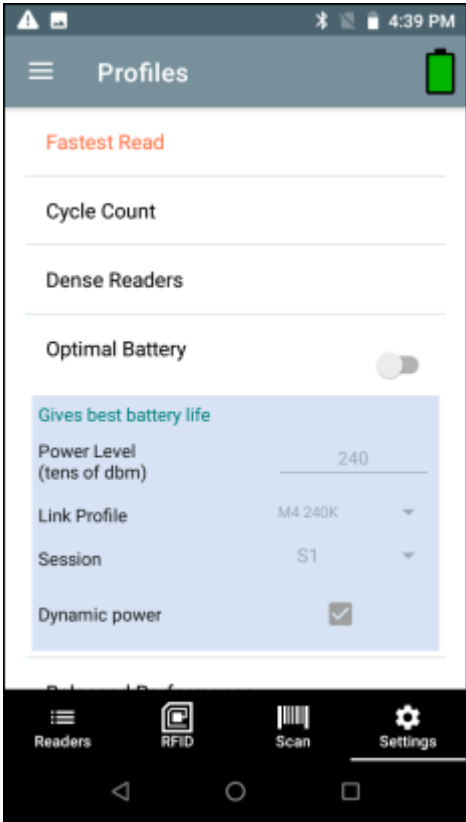

- Balanced Performance - Maintains balance between performance and battery life.

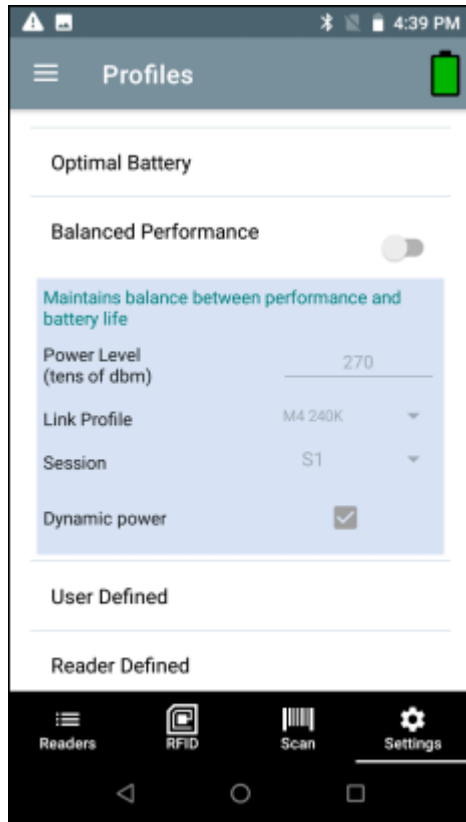

- User Defined - Custom profile used for custom requirements.

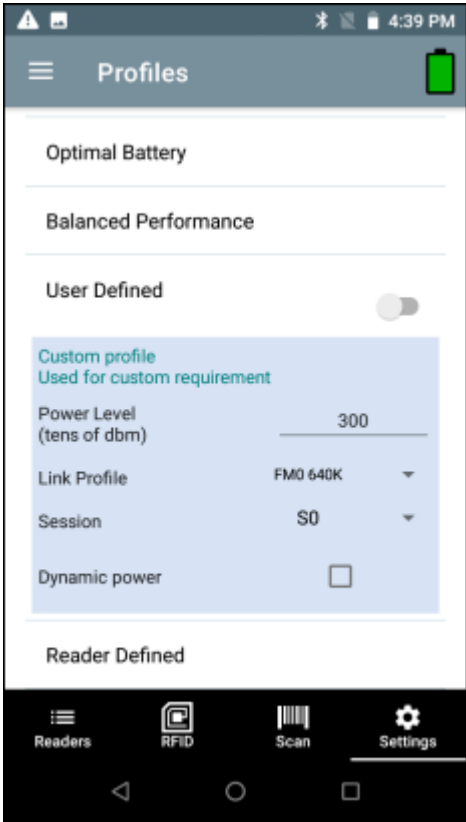

- Reader Defined - Maintains reader configurations.

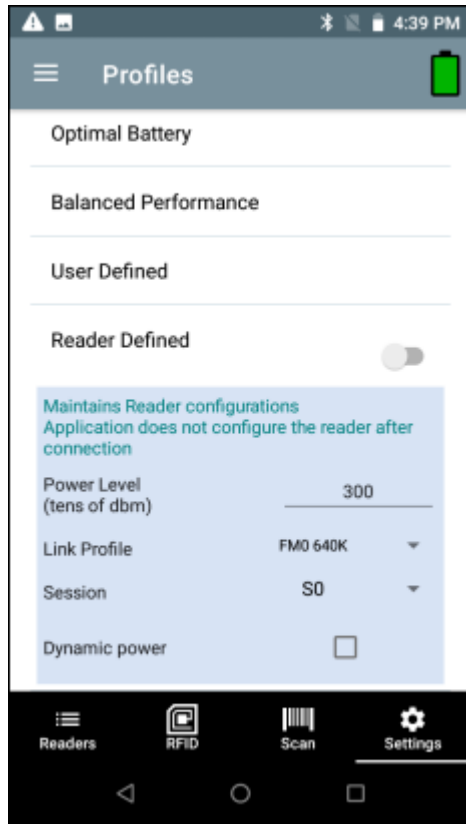

NOTE: Profile settings in orange are enabled.

Advanced Reader Options

To set advanced reader options, from the bottom navigation bar, tap **Settings > RFID > Advanced Reader Options**. Advanced Reader Options include:

- Antenna
- Singulation Control
- Start/Stop Triggers
- Tag Reporting
- Save Configuration
- Power Management

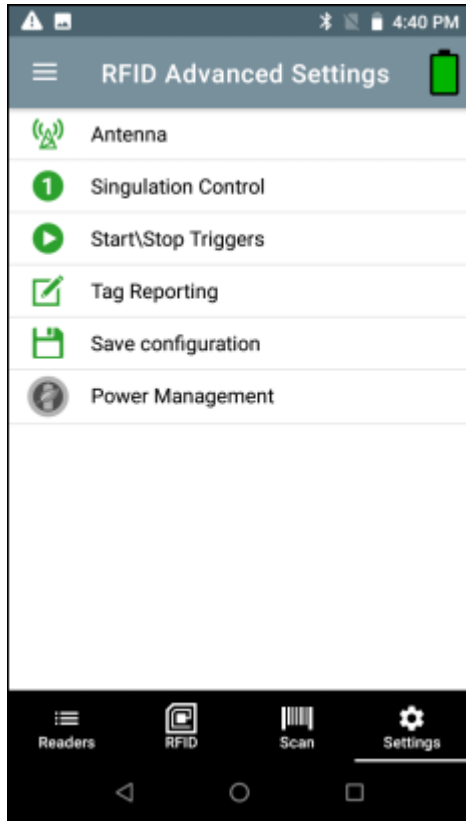

See Also

[Antenna](#)

[Singulation Control](#)

[Start/Stop Triggers](#)

[Tag Reporting](#)

[Save Configuration](#)

[Power Management](#)

Antenna

To access the Antenna screen, from the bottom navigation bar, tap **Settings > RFID > Advanced Reader Options > Antenna**. The Antenna screen displays the following:

- **Power Level** - Displays the current selection and a text box for available power levels (as reported by the device). The default setting is 27.0 dBm (shown as 270; the value displayed is in units of tens of dBm). Japan units are set to a different default power level depending on the SKU type. The minimum power level when DPO is enabled is 3.1 dBm. When DPO is disabled, the minimum power level is 0 dBm.
- **Link Profile** - Displays the current selection and includes a drop-down list of available link profiles (reported by the device). Link Profile display format is as follows: Return link bit data rate in bis per second (e.g., 60000 -> 60 Kbs); Miller Value (e.g., MV_4 -> Miller 4); thus profile name M4 240K (240K becomes BLF) modulation type (PR ASK is the only one supported).
- **PIE** - This value has no units and is either 1500 and 2000 minimum.
- **Tari** - The applicable Tari value in thousands of microseconds (e.g., 6250 -> 6.25 microseconds).

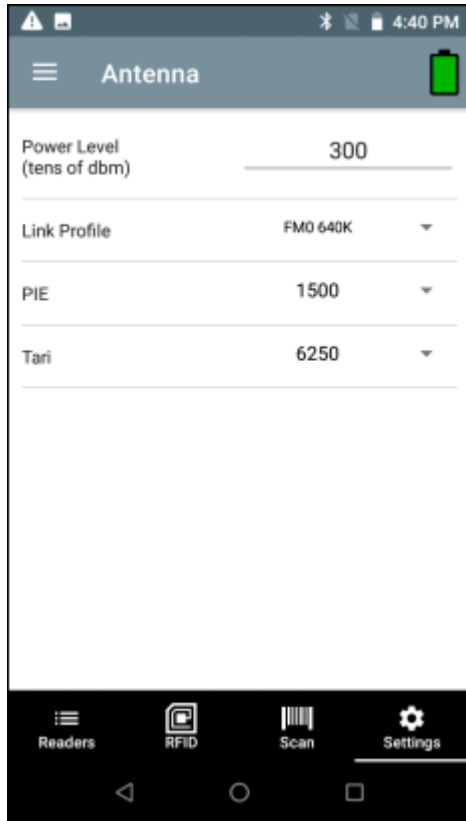

NOTE: The Antenna Power Level and Link Profile are blank when there is no connection to the reader.

Singulation Control

To access Singulation Control, from the bottom navigation bar, tap **Settings > RFID > Advanced Reader Options > Singulation Control**. View or configure the singulation control settings for each antenna.

- **Session** - The drop-down list includes the available session options (S0, S1, S2, S3).
- **Tag Population** - A numeric value of the estimated number of tags in the Field of View (FOV). Values shown are 30, 100, 200, 300, 400, 500, 600.
- **Inventory State** - State A, State B, AB Flip.
- **SL flag** - ALL, DEASSERTED, ASSERTED.

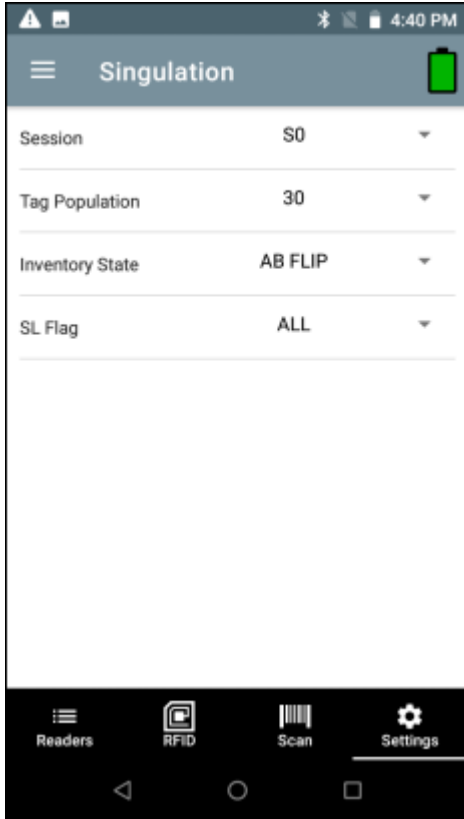

Start and Stop Triggers

To access the Start and Stop Triggers screen, from the bottom navigation bar, tap **Settings** > **RFID** > **Advanced Reader Options** > **Start/Stop Triggers**.

Start Trigger Periodic displays the **Period** input box (in milliseconds).

The **Stop Trigger Duration**, **Tag Observation** and **N attempts** display numeric value input boxes.

All time entries are in milliseconds, and all required details for saving triggers to the reader must be entered, or the application does not save the trigger settings to the reader.

Required input for **Start/Stop Trigger** settings are as follows:

- Start Trigger
 - **Immediate** (default)
 - **Handheld** - Select either the **Trigger Pressed** or **Trigger Released** check box.
 - **Periodic** - Enter the period of time in milliseconds.
- Stop Trigger
 - **Immediate** (default)
 - **Hand-held** - Select either the **Trigger Pressed** or **Trigger Released** check box along with Timeout in milliseconds.
 - **Duration** - Enter duration in milliseconds.
 - **Tag Observation** - Enter the tag count along with timeout in milliseconds.
 - **N Attempts** - Enter the number of attempts along with timeout in milliseconds.



If the **Start Trigger** type is set to Hand-held trigger (pressed or released), the application sets the repeat for the operation to ensure the use case if repeated operations can be demonstrated.

If any trigger is defined as **Hand-held**, the application does not act on immediate trigger type for a hand-held trigger action.

Tag Reporting

To access Tag Reporting, from the bottom navigation bar, tap **Settings > RFID > Advanced Reader Options > Tag Reporting**.

Tag Reporting screen options include:

- **PC** - Select to allow reporting the PC as part of the Tag Data.
- **RSSI** - Selection indicates whether or not the RSSI (Received Signal Strength Indication) is reported as part of the Tag Data.
- **Phase** - Select to indicate whether or not the Phase is reported as part of the Tag Data.
- **Channel Index** - Select to indicate whether or not the Regulatory Channel Index is reported as part of the Tag Data.
- **Tag Seen Count** - Select to indicate whether or not the Tag Seen Count is reported as part of the Tag Data.
- **BT Batchmode** - Select to enable Bluetooth batchmode.
- **USB Batchmode** - Select to enable USB batchmode
- **Report Unique Tags** - When this option is enabled, the reader reports only unique tag reads. The Unique Tag reporting feature can be enabled when using Tag List Match mode.

- **Check BrandID** - Check box to enable the Brand ID option.
- **Brand ID** - Perform NXP BrandID check (supported only on NXP U-Code 8 and above tags that supports this functionality). Brand ID check can be initiated by enabling BrandID. Reader performs an inventory operation with additional verification on whether or not the tag inventoried matches the BrandID and reports.
- **EPC Length** - The EPC length provided will consider the length of EPC data to be matched for Brand ID tags from offset 0.

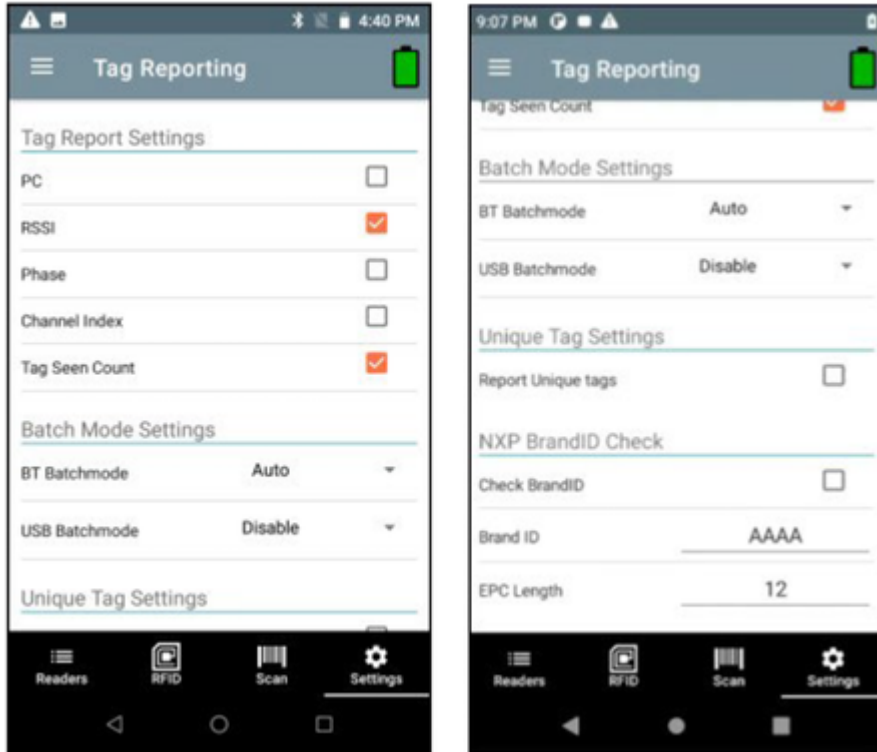

Save Configuration

To access Save Configuration, from the bottom navigation bar, tap **Settings > RFID > Advanced Reader Options > Save Configuration**.

The settings are saved on the device until a reset to factory defaults is performed on the device.

Save provides an overview of all current settings on the device.

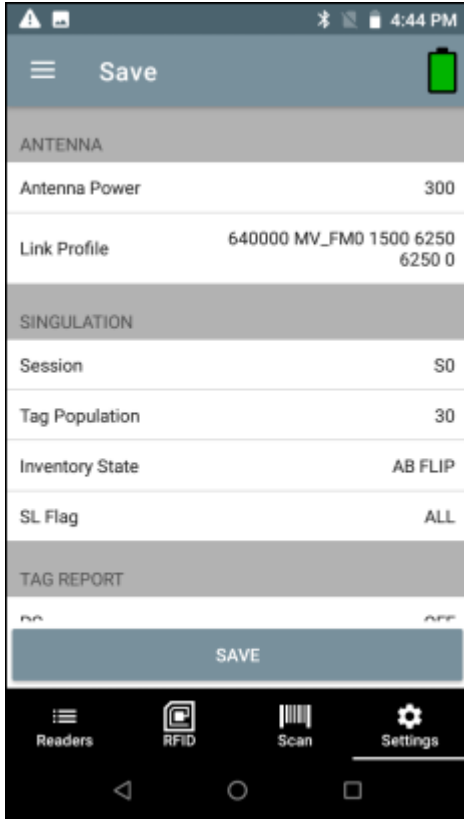

Power Management

To access Power Management from the bottom navigation bar, tap **Settings** > **RFID** > **Advanced Reader Options** > **Power Management**.

Enable Dynamic Power Optimization (DPO) to enhance battery life during inventory operations.

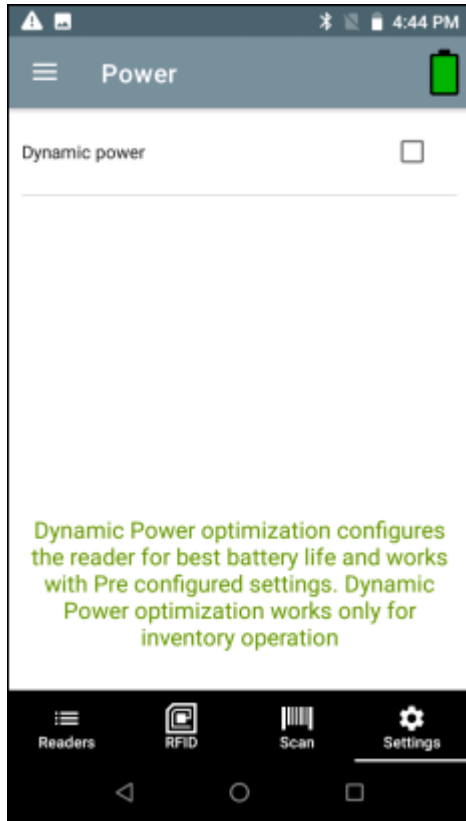

Setting a Charge Terminal

To set Charge Terminal options:

1. Tap Settings from the bottom navigation bar.

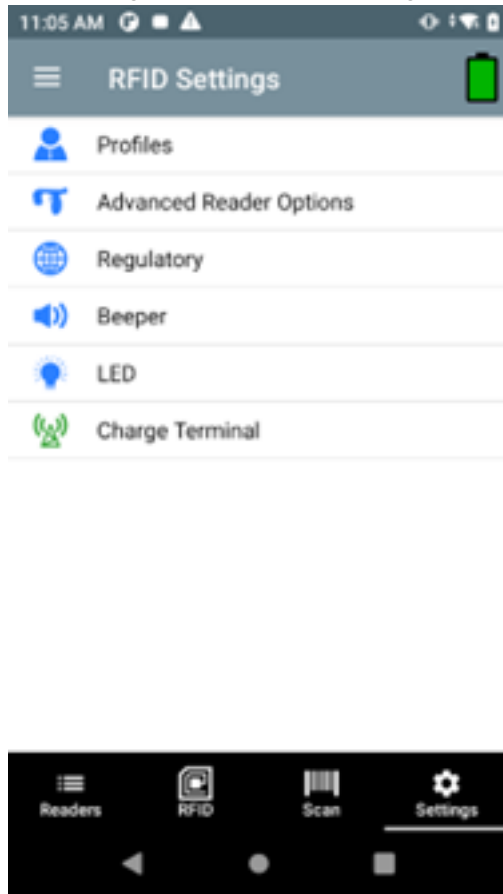

2. Enable or disable the Charge Terminal option from the checkbox.



Regulatory

1. To set regulatory options, from the bottom navigation bar, tap **Settings** > **RFID** > **Regulatory**.



WARNING: Select only the country in which you are using the reader.

2. Select the region from the drop-down list.

3. Select from the available channels.

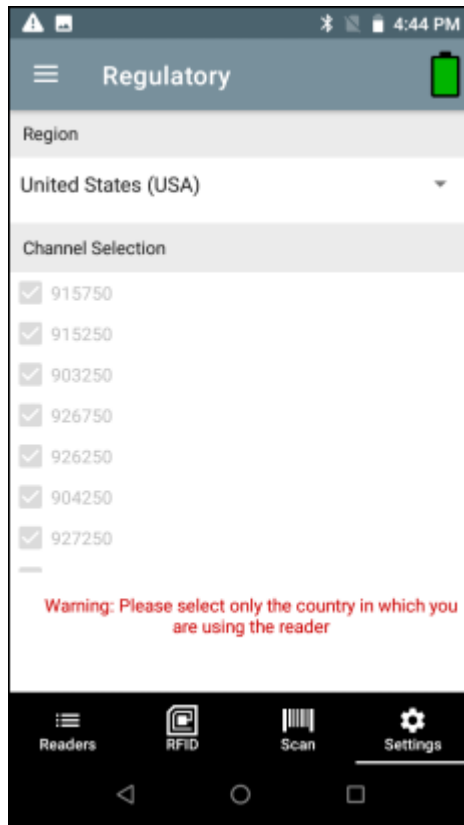

Beeper

1. To set beeper options, from the bottom navigation bar, tap **Settings > RFID > Beeper**.
2. Enable/disable the beeper on the sled.
3. Enable/disable the beeper on the host.

4. Select the volume:

- High
- Medium
- Low

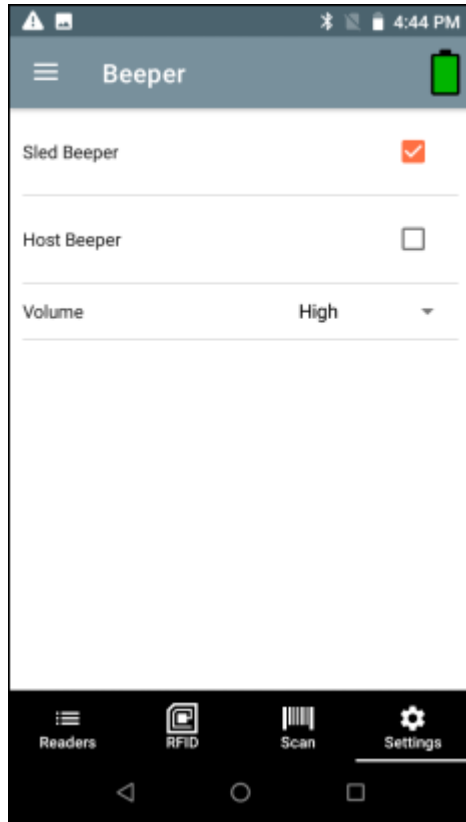

LED

1. To set LED options, from the bottom navigation bar, tap **Settings** > **RFID** > **LED**.

2. Enable/disable the LED on the host.

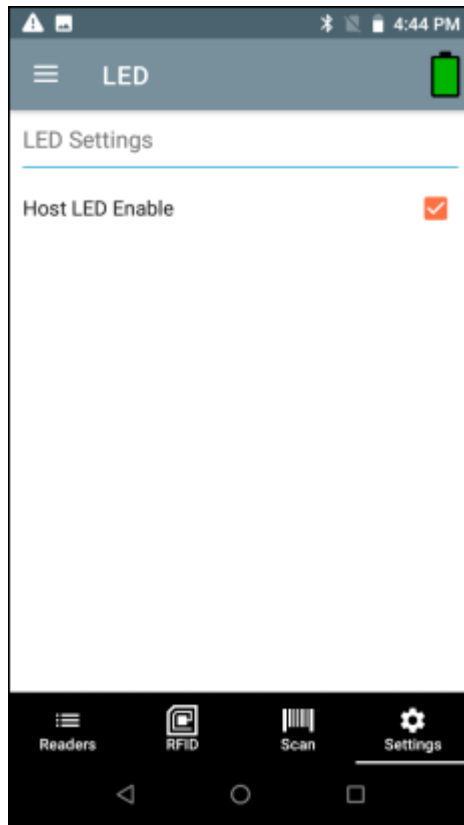

Application Settings

To access Application Settings, from the bottom navigation bar, tap **Settings > Application** or tap **☰ > Settings > Application**.

The Application Settings screen includes:

- **Auto Reconnect Reader** - When checked, the device connects to the RFID service which manages the connection to the reader.
- **Reader Connection Notification** - When checked, the application notifies the user when the reader is connected or disconnected.
- **Reader Battery Status Notification** - When checked, the application notifies the user when the battery has reached specific critical states.
- **Export Data** - When checked, the application writes the inventoried RFID data to a file when the inventory operation stops. On Android platforms the file is saved in a fixed directory. Check the files in file browsing in the Inventory directory (Sdcard/inventory/<files>). The files may be copied to a PC.

When **Profile** is set to **Cycle Count** and **Export Data** is enabled: If you start/stop inventory multiple times from the same screen, it will append cycle count data to existing data and generate a csv file (delete old csv) rather than creating a new csv file on each start/stop.

- **Tag List Match Mode** - Check to enable matching mode.
- **Show Friendly Names** - Check to show the tag's friendly names instead of EPC ID. **Show friendly names** is only available when **Tag List Match Mode** is enabled.

- **ASCII Mode** - Displays tag ID in ASCII format. If the full tag ID or memory bank data is convertible to ASCII format, then the application only shows the same. Inventory, Locate, Access, and Pre Filters show ASCII mode represented data in respective sections.

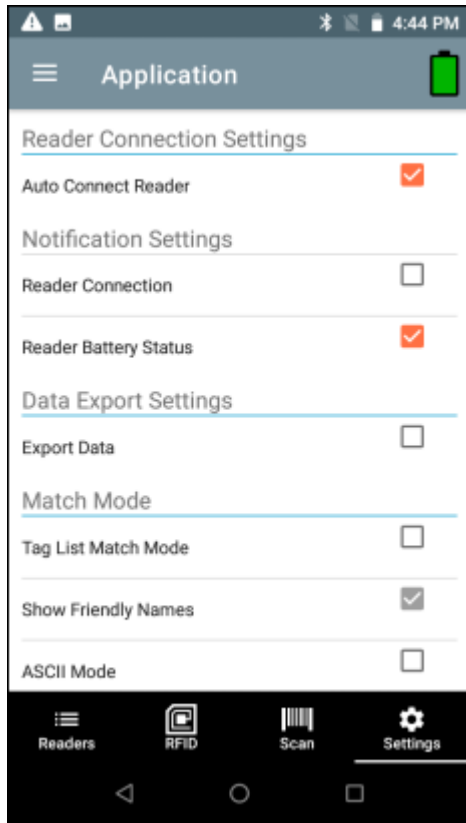

Enabling SGTIN-96

To enable SGTIN-96 tag format:

1. Tap **Settings** > **Application** from the bottom navigation bar.

2. Select the corresponding checkbox to enable SGTIN-96 Mode.

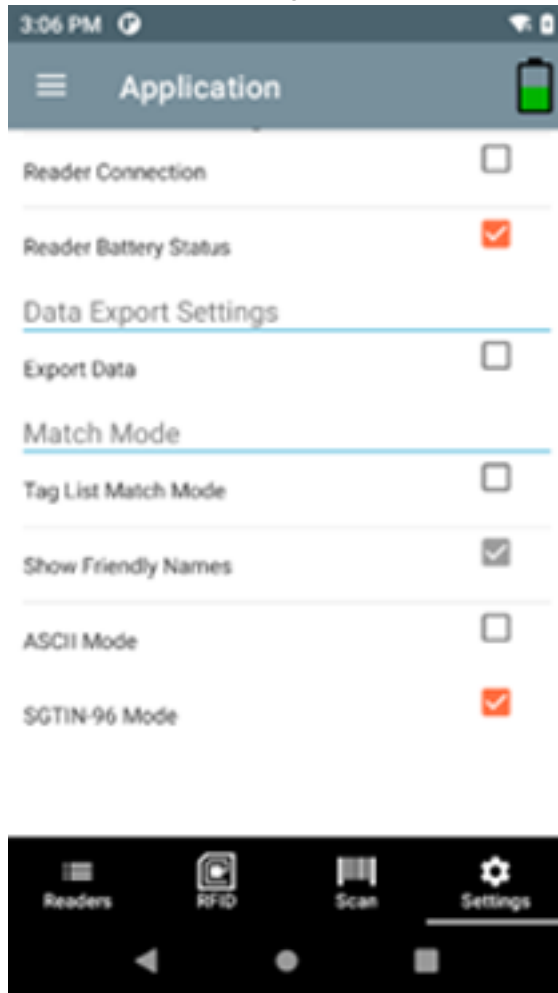

- Next, run the inventory to confirm that the changes were implemented successfully.

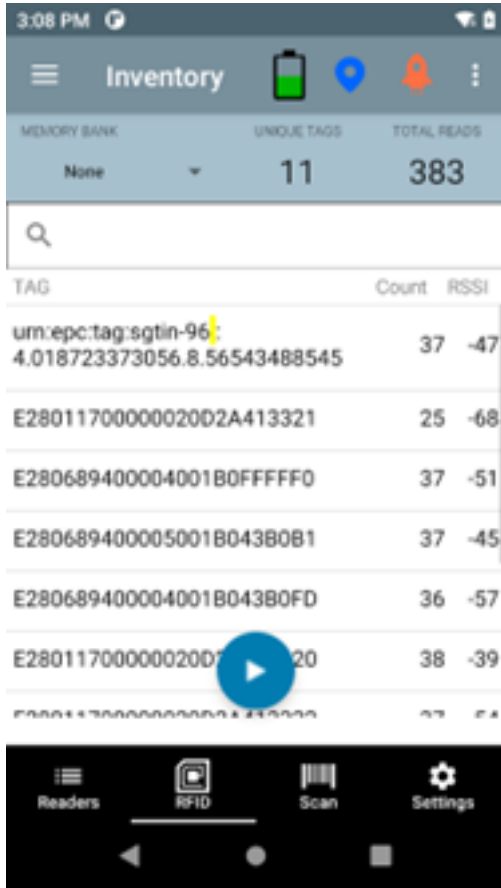

U9 Tags

1. Run the inventory and select the U9 tag.

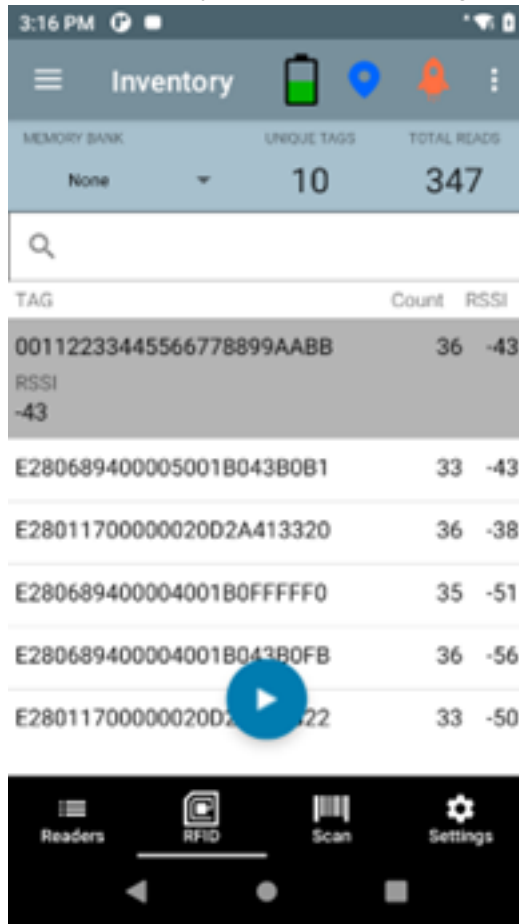

2. Tap  and select Tag Write.

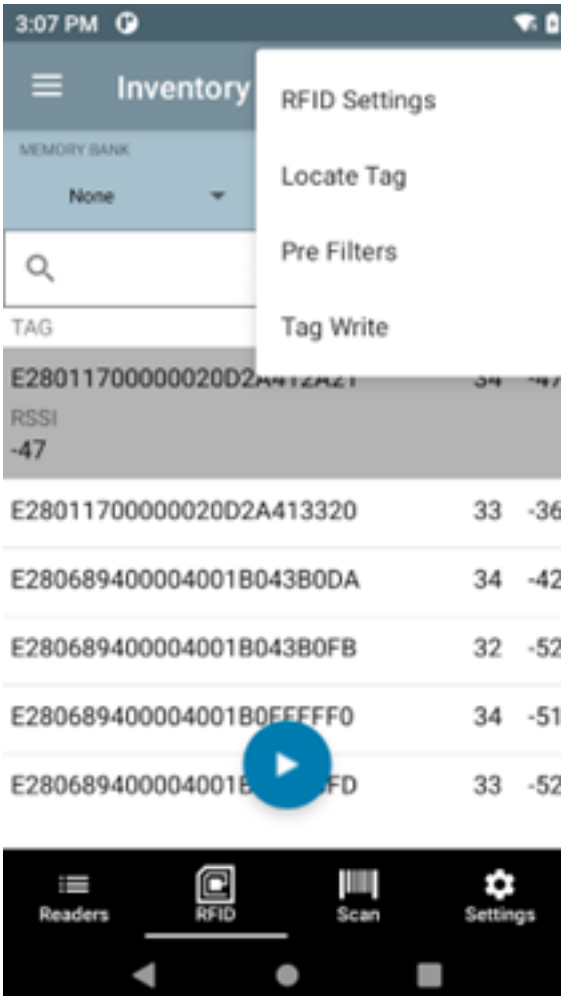

3. Select all from the Memory Bank drop-down menu on the Lock tab.

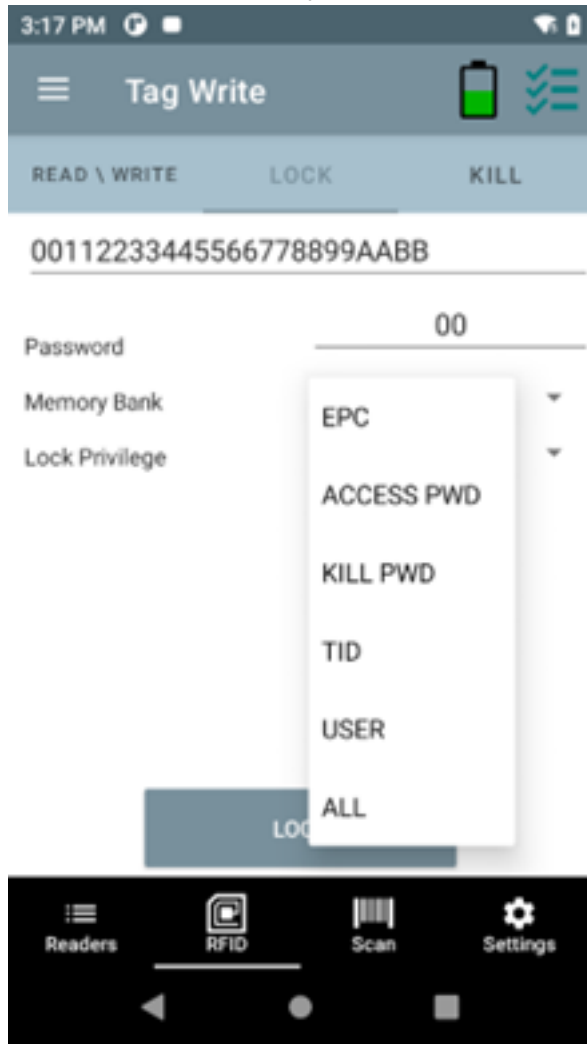

4. Click Lock to lock the tag permanently.



Scan Settings

To access Scan Settings, from the bottom navigation bar, tap **Settings > SCAN** or tap **☰ > Settings > SCAN**. Scan Settings options include:

- **Beeper** - Provides the option to change the scanner beeper volume to high, medium, or low.



NOTE: Available only on sleds with an imager.

- **Symbologies** - Allows users to select/enable specific barcode types. Supported symbologies include UPC-A, UPC-E, UPC-E1, EAN-8/JAN8, EAN-13/JAN13, Bookland EAN, Code 128, GS1-128, Code 39, Code 93, Code 11, Interleaved 2 of 5, Discrete 2 of 5, Chinese 2 of 5, Codabar, MSI, Code 32, Data Matrix, PDF417, ISBN, UCC Coupon Extended Code, ISSN EAN, ISBT 128, Trioptic Code 39, Matrix 2 of 5, Korean 3 of 5, GS1 DataBar-14, GS1 DataBar Limited, GS1 DataBar Expanded, MicroPDF417, Maxicode, QR Code, Aztec, Han Xin Code, Australian Post, US PLANET, US POSTNET, Netherlands KIX, USPS 4CB, UK Postal, Japan Post, UPU FICS, MicroQR, Composite C, Composite AB, TLC39, Dot Code.
- **Picklist Mode** - Toggle to turn picklist mode on or off. The default is Off.
- **Aim Guide** - Provides an aimer light that can be switched on or off.

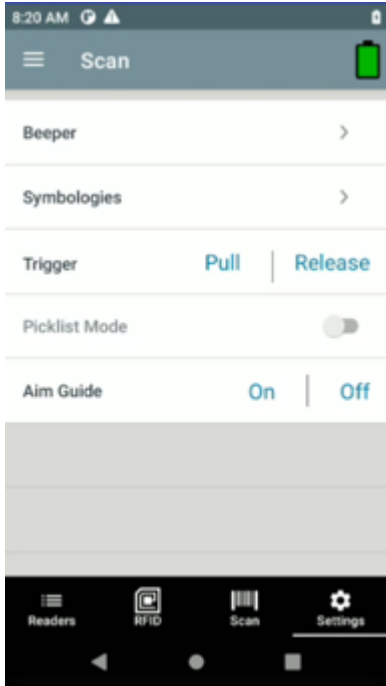

Certificates Management Settings

Configure the Certificates Management settings using 123RFID Mobile.

To access Certificates Management settings, from the bottom navigation bar, tap **Settings > Certificates Management** or tap **☰ > Settings > Certificates Management**. The Certificates Management settings options include:

- **Add New** - Add new certificates to the reader.
- **Remove All** - Remove all the certificates in the reader.

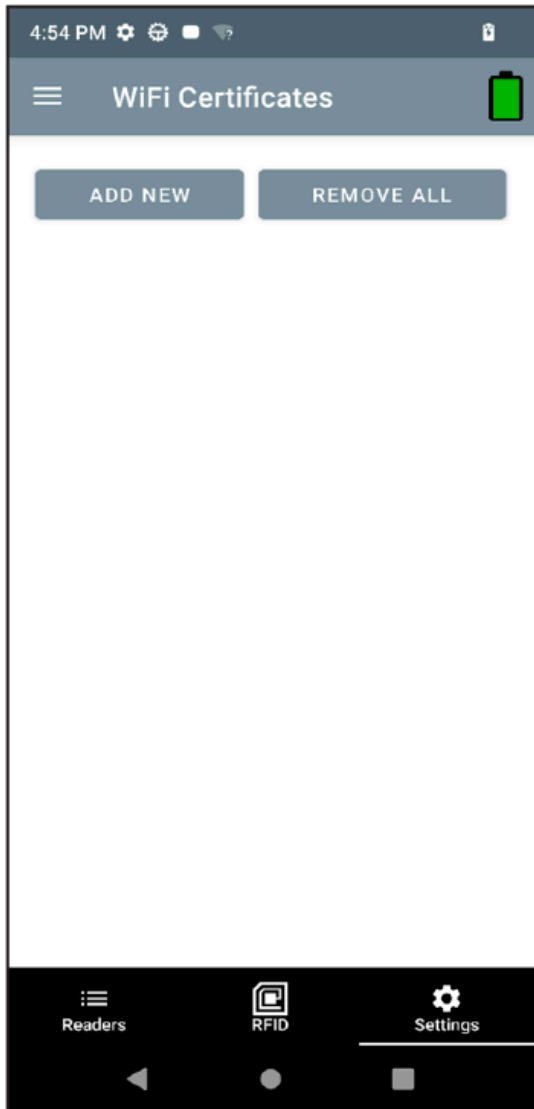

1. To add a new certificate, tap **Add New**.
2. Select one of the following interface:
 - Wi-Fi
 - MQTT
 - Filestore
 - Others
3. Select the type of certificate:
 - Ca_cert
 - Client_cert
 - Client_key
4. Browse and select the required certificate.

5. Tap **Upload Certificate** to upload the certificate.

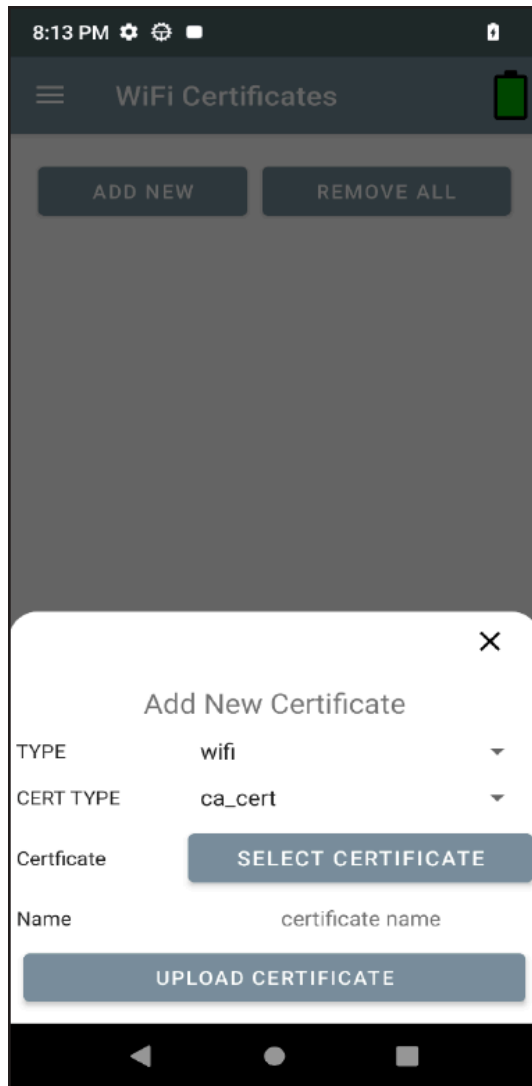

Endpoint Configuration Settings

To access Endpoint Configuration settings, from the bottom navigation bar, tap **Settings > Endpoint Configuration** or tap **☰ > Settings > Endpoint Configuration** .

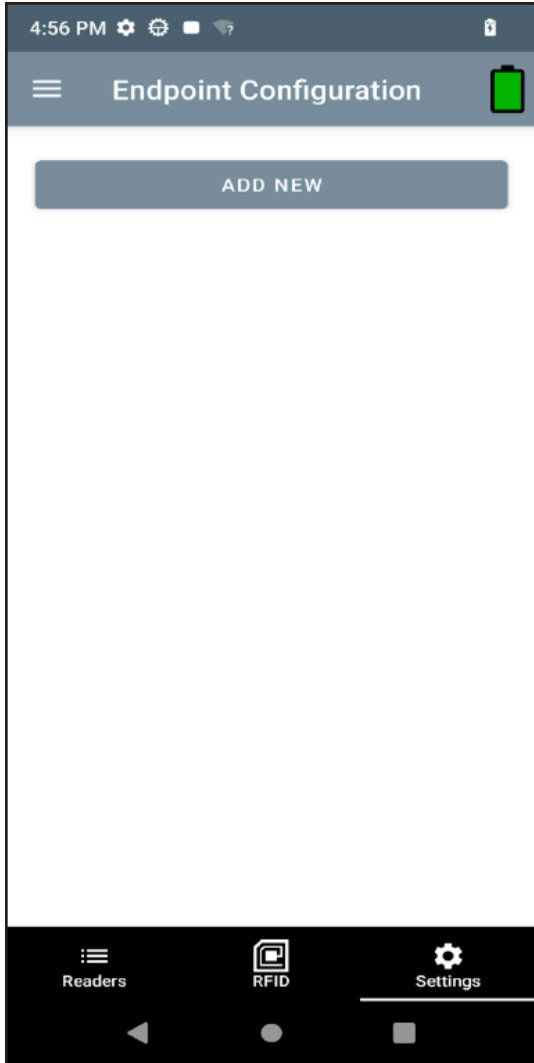

1. To add a new endpoint configuration, tap **Add New**.
2. Enter the endpoint name.
3. Select the type of endpoint:
 - SOTI
 - MDM
4. Select the protocol:
 - MQTT
 - MQTT_TLS
5. Enter the URL or server address, Port, Keep Alive, and Tenant ID.
6. Enter the minimum delay time to reconnect in the Min Reconnect Delay setting.
7. Enter the maximum delay time to reconnect in the Max Reconnect Delay setting.

8. Enter the Username and Password.

9:58 PM

Endpoint Settings

Name rfid

Type SOTI

Protocol MQTT

URL google.com

Port 8080

KeepAlive (secs) 30

TenantId abc

Clean Session

Min Reconnect Delay (secs) 2

Readers RFID Settings

10:14 PM

Endpoint Settings

Port 8080

KeepAlive (secs) 30

TenantId abc

Clean Session

Min Reconnect Delay (secs) 2

Max Reconnect Delay (secs) 2

HostVerify VERIFY_NONE

Username rfid

Password

Readers RFID Settings

9. Check the checkbox to activate the endpoint configuration and uncheck to de-activate it.



Tap  to modify or edit the endpoint configuration.

Tap  to delete the corresponding endpoint configuration.

Getting Help

On-screen help is available within 123RFID Mobile Application.

To access the Help screen, tap  > **Settings** > **Help** or when available, tap the question mark icon in the upper right screen.

